

# Homeowners Guide

## 用户手册

ST40 INTELLIGENT TOILET

ST40智能坐便器

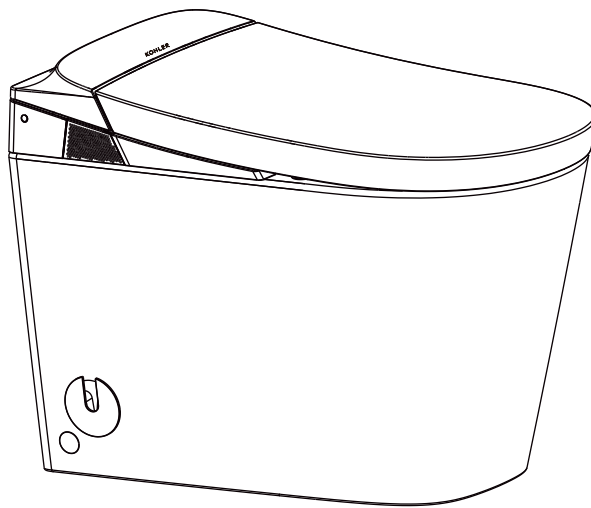

科勒（中国）投资有限公司

中国上海市静安区江场三路158号 邮编：200436

制造商：上海科勒电子科技有限公司

中国上海市宝山区丰翔路1955号 邮编：200444

English page 2-26

中文页码 27-50

1637875-T5-B

THE BOLD LOOK  
OF **KOHLER**®

## Thank You For Choosing Kohler Company

Thank you for choosing a Kohler product. Kohler craftsmanship offers you a rare combination of proven performance and graceful sophistication that will satisfy you for years to come. The dependability and beauty of your Kohler product will surpass your highest expectations. We are very proud of our products here at Kohler and we know you will be too.

Please take a few minutes to study this Homeowners Guide. Pay special attention to the care and cleaning instructions.

All information in this manual is based upon the latest product information available at the time of publication. At Kohler, we constantly strive to improve the quality of our products. We reserve the right to make changes in product characteristics, packaging or availability at any time without notice.

# Catalogue

Thank you for choosing Kohler Company.....	2
Cautions and warning.....	4
Specification.....	6
Overall diagram.....	7
Remote control user guide.....	8
Remote controller setting guide.....	10
Preparations before the initial use.....	12
Cover/Seat OPEN/CLOSE funtion.....	13
Flushing your toilet.....	14
Clean foam function.....	16
Foot sensor function .....	16
Auxiliary button board function.....	17
Standby mode.....	18
UV sterilization function.....	18
Energy saving function.....	18
Deodorization.....	18
Prolonged seating indication.....	19
Water temperature/seat temperature auto adjustment feature.....	19
Maintenance and cleaning.....	19
Trouble shooting.....	24
Description of Content of Hazardous Substances in Product.....	26

# Cautions and Warnings

- In case the power cord is damaged; to avoid danger, product should be replaced by the manufacturer or the professionals from its maintenance department or similar departments.
- The minimum inlet pressure is 0.07MPa (dynamic pressure), and the maximum inlet pressure is 0.74MPa.
- New hose components that come with the equipment must be used, and old hose components cannot be reused.
- This product must be installed safely. Connect only to dedicated 220V~, 50Hz, 10A circuit protected by Ground-Fault Circuit-Interruption (GFCI's) or Earth-Leakage Circuit-Breakers (ELCB's).

## Warning

 **Warning:** any misuse from ignoring the content of this label may cause serious injury or death.

- The installation should be subject to the instructions before the power is connected.
- Do not use any hard setting material (cement mortar) while installing the toilet.** Thermal expansion of hard setting material (cement mortar) will damage or crash the feet of toilet. Kohler will not be responsible for any damage because of using hard setting material (cement mortar) for toilet installation.
- Risk of product damage.** Do not throw into the toilet what that will cause the toilet to block such as newspapers and sanitary towel. Do not bump the vitreous china with great force as it will cause damage and leaking.
- Risk of electric shock or product damage.** Do not immerse the product into water.
- Risk of product damage.** The power shall not be connected before the work is finished. Otherwise it may lead to product failure.
- When an electrical product is used, especially when children are near, the following basic safety precautions shall be followed:
  - Danger-Reduce risk from electric shock:**
    - Do not place or store this device where it can fall or be dropped into a bath or sink.
    - Do not place in or drop into water or other liquid.
    - Do not make any contact with the product drop into the water, unplug immediately.
- Do not operate this device if following occasions occurred: damaged cord or plug; if it is not working properly or if it has been dropped into water.
- Keep power cord far from heated surface.
- Prevent water splash on power plug.

## Note

 **Note:** any misuse from ignoring the content of this label may cause personal injury or product damage.

- Risk of product damage.** Do not install at a place where it may be splashed by water.
- Risk of product damage.** Do not install the product at a place with excessive humidity, where moisture may condense at the surface of the product. Please maintain that the usage environment is under adequate ventilation, so as to prevent damage to electronic components.
- Risk of product damage or property loss.** Water leakage may happen if the water pipe connector is pulled or pressed with excessive force.
- Risk of product damage.** The product may be damaged if the nozzle is applied with excessive force.
- Risk of product damage.** The part of the pipe where water may be frozen should be protected by thermal insulation. Any water left in the product may be frozen during the winter season. Please keep the product in room temperature before reinstallation or usage.
- The thermal protector may be out of order during storage or transportation in warm climate which can lead to product failure. Please ensure the product cools to room temperature before reinstallation or usage.

## Cautions and warning (cont.)

### **WARNING - To reduce the risk of low grade burns, electric shock, fire or injury to persons:**

- Children, elders or those with disabilities from their body, sensitivity or mental disabilities or lacking of common sense should not use or get close to this product unless under close tutelage. Children are not allowed to use or touch this product. Do not leave children alone in a room with such product.
  - For those children and the elderly who are unable to adjust the temperature, they should ask for help to adjust seat temp, water temp and wind temp of toilet cover to proper gears.
  - Prevent any exposed skin contact with heated seat too long to prevent low temperature burning.
- This device complies with the method described in the manual. Do not use attachments not recommended by Kohler Co. such as angle valve etc.
  - Do not lean on cover when use this device to prevent product from damage.
  - Following the installation procedure and install the product properly.
  - This product shall be repaired by professionals only. The warranty will become invalid if you try to repair this product by yourself.
  - When install the product in the room, a stop valve shall be installed in a close proximity. For emergency circumstances, the water inlet valve shall be stopped without using any tools; otherwise unexpected failure may cause the loss to the customer.
  - Do not drop or insert any substance to pipeline or any opening holes.
  - Do not use this product outdoor or in a place where a particle mist spray device is used, neither at a place using oxygen supply.
  - UV sterilization devices should be installed and maintained by qualified servicemen.
  - Please use the water supply hose accompanying with new machine. The old hose assembly shall not be used again.
  - When user cut power supply off, if reactivation of power supply is required, please wait until the end of “beep.....” indication, and then turn on power supply again.
  - Stop using product if any of the circumstances observed below. Shut power off and stop water inlet valve immediately.
    - Water hose and internal water leak from inside out.
    - When product is cracked or damaged.
    - When abnormal sound or obvious odour appears.
    - Product smokes.
    - Abnormal product heating problem.
  - Do not charge non-rechargeable battery.
  - Remove used battery from appliance and dispose properly.
  - Remove battery if appliance is going to store for a long term.
  - No short circuit on power supply terminal.
  - Prevent remote control from splash water.
  - Do not add bleach, preservatives, cleaning agents, chemicals to the inside of the tank and ceramic, which may cause damage to the components and pipes in the tank and ceramic .

Specification			
Flush volume		4.0L	
Water Efficiency Rating*		Level II	
Pit-Wall Distance		305/400mm	
Water Supply Pressure		Min inlet water pressure: 0.07MPa (dynamic) Max inlet water pressure: 0.74MPa	
Rated Voltage		220V~, 50Hz	
Rated power*		1040W	
Power cord length		Total Length is about 1.5m,About 1.2m in outside	
Product Outline dimension		About 680mm×368.7mm×506mm	
Product weight		About 40kg	
Inlet Water temp		1-35°C	
Ambient temp		1-40°C	
Clean	Rear Wash		YES, adjustable
	Front Wash		YES,adjustable
	Water flow (water pressure 0.2MPa)		Max rear wash shall be no less than 500mL/min
	Adjus clean water temp		OFF, adjustable 3 dials (low, mid, high) / Auto setting (available only when water temperature/seat temperature function is activated)
	Cleaning time (max.)		About 300s
	Nozzle Position Adjustment		3 dials
	Pulsate Massage		ON/OFF
	Oscillate		ON/OFF
	Hot and cold alternation (only for Rear wash)		ON/OFF
	Safety Devices	Water overtemp protection	Thermal fuse
Backflow prevention		Check valve	
Comfort	Seat temp preservation	Temp adjustment	OFF, adjustable 3 dials / Auto setting (available only when water temperature/seat temperature function is activate)
		Safety device	Thermal fuse
	Cover		Auto OPEN/CLOSE, slow swing, remote OPEN/CLOSE
	Seat		Slow swing, remote OPEN/CLOSE
	Dryer	Dryer funciton	Yes
		Safety device	Thermal fuse
	Deodorizer function		Yes
Remote		Yes, function setting refers to “Remote Control user guide” .	
Sanitation	Self-Cleaning of Spray Nozzle		Yes
	Antibacterial Material		Cover/Seat / Overall coating/Whole machine shell
	UV sanitizing		Yes
Other Features	Other Safety device		Circuit breaker
	Auxiliary buttonboard		Yes
	Seating detection		Located inside the seat
	Automatic switch cover		Microwave induction
	Emergency flush		Yes
	Night light		Yes, it is only used for internal lighting of the toilet and does not have external lighting function
	Foot sensor function		Yes
Clean foam function		Yes	

\* A note on the water efficiency mark on the intelligent toilet: The water efficiency mark indicates the intelligent toilet's conformity to a water efficiency level.

\* Power value test conditions: dynamic pressure: 0.2MPa; inlet water temperature: 15°C.

# Overall diagram

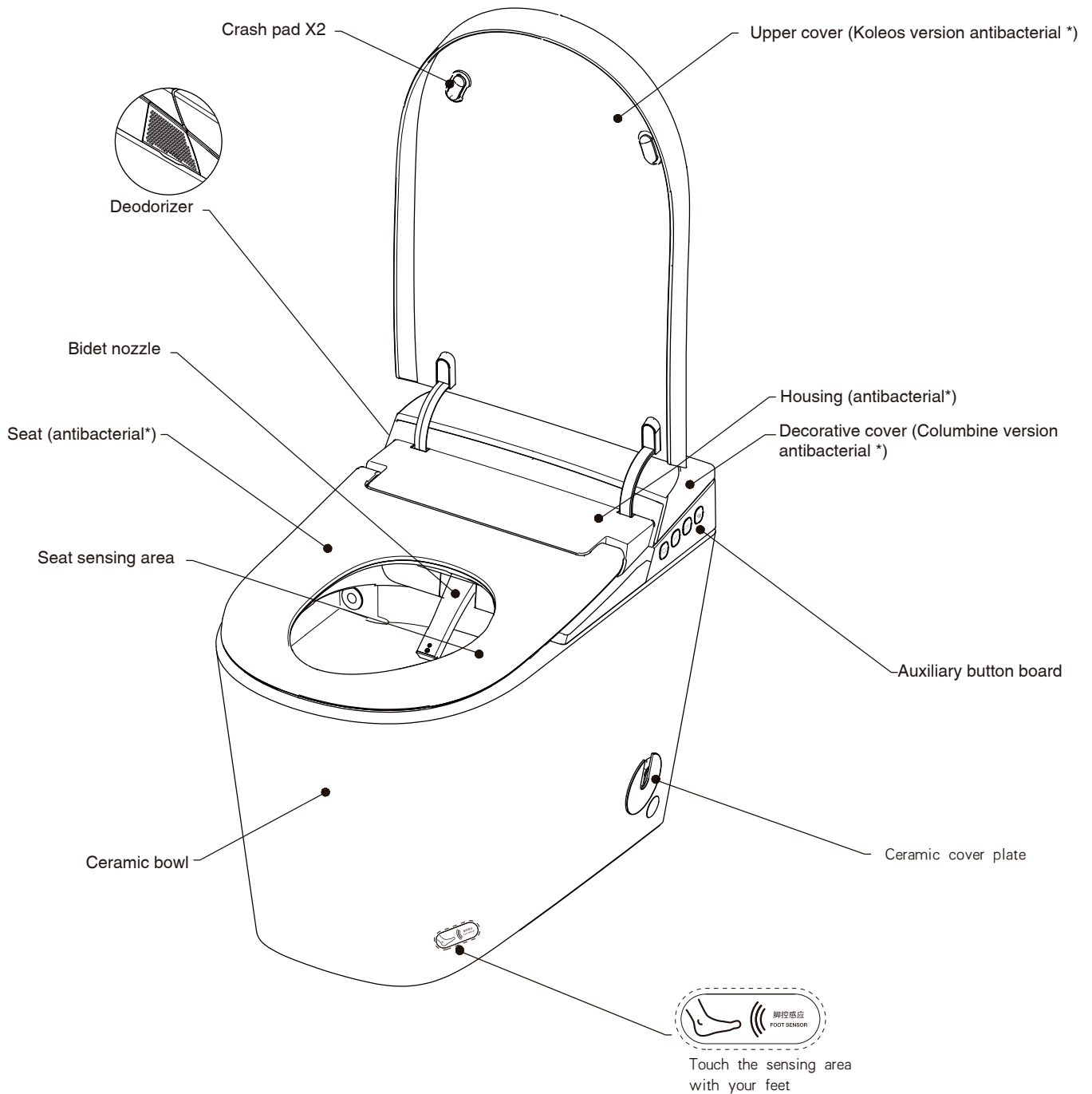

\* Antibacterial: the seat contains long term inorganic anti-bacteria material which will inhibit bacteria growth on surface, this does not represent the mildew and other incidental effects. The antibacterial rate is more than 90%. (Perform test in accordance with GB21551.2-2010 requirements. Testing lab: China household electrical appliances testing institute; electromechanical products testing technology center of Shanghai Entry-Exit inspection and quarantine bureau.)

# Remote Control User Guide

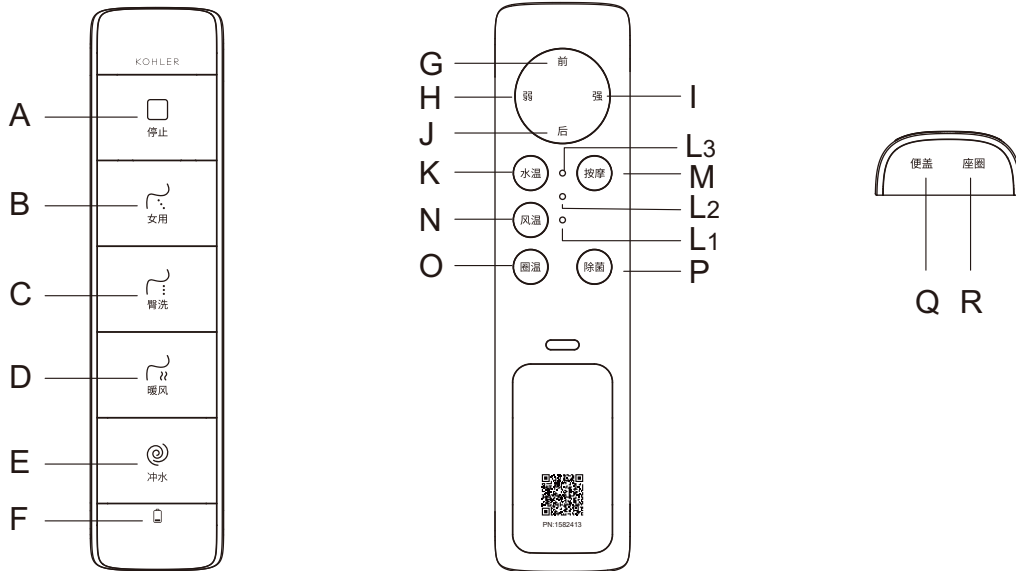

 **Note:** Remove remote control from bracket before operation so to prevent risk of falling (non anti-thief installation).

## A – Stop

- Press this button to stop the Front Wash, Rear Wash, Dryer, deodorization, and Manual Nozzle Clean or UV Sanitation, Clean foam function.

## B – Front Wash

- After sitting down, press this button to start the front wash, which will automatically stop in about 5 minutes or stop immediately after pressing the STOP button.

## C – Rear Wash

- After sitting down, press this button to start the rear wash, which will automatically stop in about 5 minutes or stop immediately after pressing the STOP button.  
Long press this button to activate the manual foam cleaning function.

## D – Dryer

- After sitting down, press this button to start the dryer, which will automatically stop in about 4 minutes or stop immediately after pressing the STOP button. (There are four levels of dryer temperature. When all indicators light OFF, the dryer temperature is room temperature.)

## E – Flush

- Press this button to flush.

## G – Forward

- Press this button to adjust the spray position forwards. There are three spray positions.  
Only available when the Rear Wash function is activated. In the "female" function mode, the nozzle position cannot be adjusted.
- When unseated, long press this button to make the spray draw out and start the Manual Nozzle Clean.  
This function is used to manually clean the spray nozzle. This function can be stopped by pressing the STOP button or long pressing the Backward button.

## J – Backward

- Press this button to adjust the spray position backwards. There are three spray positions.

## H – Weak

- Press this button to reduce the cleansing intensity.  
Press this key for a long time, and then press the "Massage" key briefly for foam liquid suction.  
(Note: For the initial injection of foam liquid into the fluid storage box or replacement of foam liquid, the foam cleaning function can be used normally after the liquid suction operation is required)

## I – Strong

- Press this button to increase the cleansing intensity.

# Remote Control User Guide

## K – Water Temperature

- Press this button to adjust the water temperature. (In normal mode, there are four levels of water temperature. When all indicators light OFF, the water temperature is 25°C, In the automatic temperature adjustment mode of the water temperature circle, add 1 automatic gear, and the L3 light on the icon will light up.)

## M – Massage

- Press this button to enter the mobile flushing mode, press again to activate the pulse flushing mode, press the pulse/mobile button simultaneously for the third time, press the hot and cold alternation button for the fourth time (only for rear washing), and press the fifth button to exit the massage mode.  
When the corresponding function is activated, L1 lights up during mobile flushing, L1, L2 lights up during pulse flushing, L1, L2, L3 lights up during simultaneous pulse/mobile flushing, When all indicator lights turn off, the temperature of the dryer is at room temperature.)

## N – Dryer Temperature

- Press this button to adjust dryer temperature. (In normal mode, there are four levels of dryer temperature. When all indicators light OFF, the dryer temperature is room temperature.)

## O – Seat Temperature

- Press this button to adjust the seat temperature level and adjust the seat heating temperature. (In normal mode, there are four levels of seat temperature. When all indicators light OFF, the seat temperature is room temperature, In the automatic temperature adjustment mode of the water temperature circle, add 1 automatic gear, and the L3 light on the icon will light up.)

## P – UV Sanitation

- Press this button for UV Sanitation. (Note: When UV sanitating is running, users cannot use the toilet.)

## Q – Cover

- When unseated, press this button to perform Cover OPEN/CLOSE action.

## R – Seat

- When unseated, press this button to perform Cover OPEN/CLOSE action.

## Low-voltage alarm

**Note: Please replace battery in time when the voltage alarm starts.**

- When F battery alarm icon blinks indicate remote battery is almost used up. Replace battery is required.

## Pairing

- After the toilet is powered up normally, long press the Dryer Temperature button for 2 seconds to turn ON the level indicators L1, L2 and L3 one by one within 1 second, and then keep all of them on for 0.8 seconds to enter the pairing mode. In the remote pairing mode, keep the level indicators blinking like a scrolling marquee light for less than 30 seconds while simultaneously pressing the Front Wash and Rear Wash buttons on the side panel on one side of the main body to let the toilet enter the pairing mode, and then the buzzer will emit a buzz. If all of the indicators on the remote light ON, the pairing is successful.  
If the pairing is not successful within 30 seconds, all of the level indicators will light OFF and re-pairing will be needed.

## Remote controller setting guide

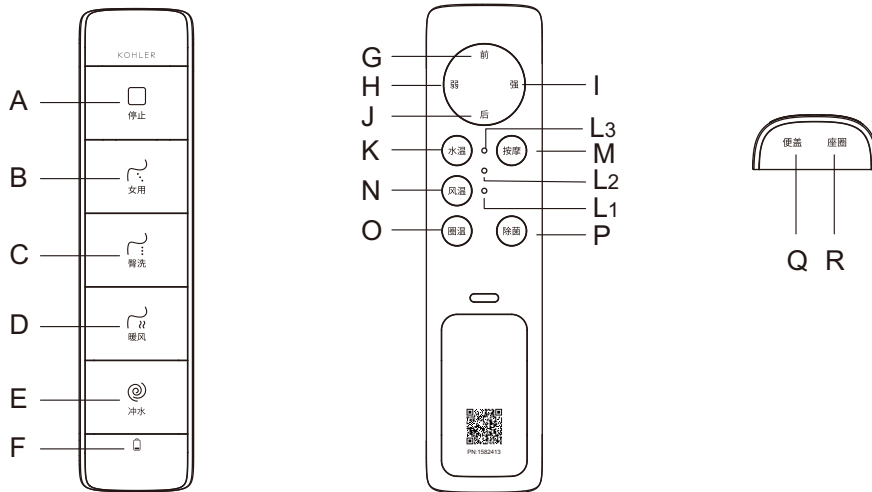

**Note:** Long press the Full Flush button on the side panel on one side of the main body until you hear a short beep. Release the button and then you can change the settings by following the steps below.

### B – Female Chong: Automatic night light setting

- Long press this button to turn on/off the automatic night light function. A short beep from the body indicates it is turned on, and a long beep indicates it is turned off.

### D - Dryer: Clean foam function setting

- Long press this button to set the automatic foam cleaning function on or off. Short press the Dryer button to display the previous status, then short press the Dryer button again to switch the status. A short beep from the main body indicates that it is turned on, A long beep indicates closure.

### I – Strong: Automatic flushing setting

- Long press this button to enter the automatic flushing setting mode. Short press Strong button to switch the status.
  1. When all level indicators light ON, the function of automatic flushing without closing the cover is enabled.
  2. When level indicator L2 lights ON, the function of automatic flushing with cover closed is enabled.
  3. When all level indicators light OFF, the automatic flushing function is disabled.

### H – Weak: Automatic deodorization setting

- Long press this button to enter the automatic deodorization setting mode. Short press the UV Sanitation button to display the previous status, and short press the UV Sanitation button again to switch the status.
  1. When all level indicators light ON, the automatic deodorization function is enabled.
  2. When all level indicators light OFF, the automatic deodorization function is disabled.

### K – Water Temperature: Automatic water temperature and seat temperature adjustment setting

- Long press this button to enter the automatic water temperature and seat temperature adjustment setting mode. Short press Water Temperature button to switch the status.
  1. When all level indicators light ON the automatic water temperature and seat temperature adjustment function is enabled.
  2. When all level indicators light OFF the automatic water temperature and seat temperature adjustment function is disabled.

### M – Massage: Long sitting reminder function setting

- Long press this button to enter the long sitting reminder function setting mode. Short press Massage button to switch the status.
  1. When all level indicators light ON, the long sitting reminder function is enabled.
  2. When all level indicators light OFF, the long sitting reminder function is disabled.

### O – Seat Temperature: Energy saving setting

- Long press this button to enter the energy saving setting mode. Short press Seat Temperature button to switch the status.
  1. When the level indicator L1 lights ON, the energy saving function is disabled.
  2. When the level indicator L2 lights ON, the general energy saving function is enabled.
  3. When the level indicator L3 lights ON, the comprehensive energy saving function is enabled.

# Remote Control User Guide

## P – UV Sanitation: Automatic sanitation setting

- Long press this button to enter the automatic sanitation setting mode. Short press UV Sanitation button to switch the status.
  1. When all level indicators light ON, the automatic sanitation function is enabled.
  2. When all level indicators light OFF, the automatic sanitation function is disabled.

## Q – Cover: Microwave level setting

- Long press this button to enter the microwave level setting mode. Short press Cover button to switch the status.
  1. When all level indicators light OFF, the microwave function is disabled.
  2. When the level indicator L1 lights ON, the low-level microwave function is enabled.
  3. When the level indicators L1 and L2 light ON, the medium-level microwave function is enabled.
  4. When all level indicators light ON, the high-level microwave function is enabled.

## R – Race: Setting the closing time for automatic lid flushing

- Long press this button to enter the automatic lid closing and flushing time setting mode, and short press the seat ring button to switch states.
  1. When the gear light L1 is on, it indicates that the automatic cover closing time short gear function has been activated.
  2. The gear lights L1 and L2 are on, indicating the activation of the automatic lid closing time mid-range function.
  3. If the gear light is fully on, it indicates that the automatic lid closing time long gear function has been activated.

## J – After: Foot sensation function settings

- Long press this key to enter the foot sensation function setting mode, and short press the After key to switch states.
  1. When the gear light is fully on, it indicates that the foot feel function has been activated.
  2. If all gear lights are off, it means the foot feel function is turned off.

Note: When long pressing any function button to set any function, if you make no action or press other buttons within 10 seconds, the function setting will be exited.

A short beep indicates that the function is enabled. A long beep indicates that the function is disabled.

## Remote control battery usage and replacement

- Remote docking station uses two AA alkaline batteries.
- When battery is low, remote red LED blinks and lights ON, indicates the replacement of battery.

### ● NOTE:

1. The +/- polarities of battery must be consistent with the mark of remote.
2. Do not mix new and old batteries.
3. Please use alkaline battery.

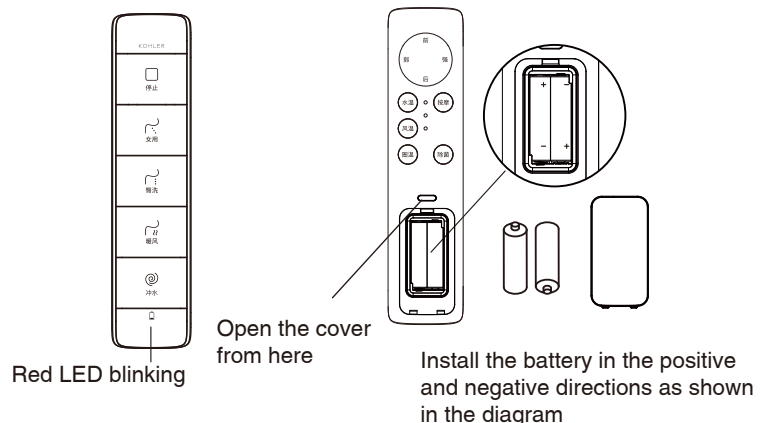

## Others

- Prevent liquid from spraying the remote or do not soak remote into the liquid.
- Do not place remote around the small household appliances, such as hand dryer or hair dryer etc. to prevent remote from interference.
- Do not apply frequent and violent external force on remote buttons.
- Place remote back to docking station on the wall after usage.
- Prevent remote from dropping in the process of use.

## Preparations before the initial use

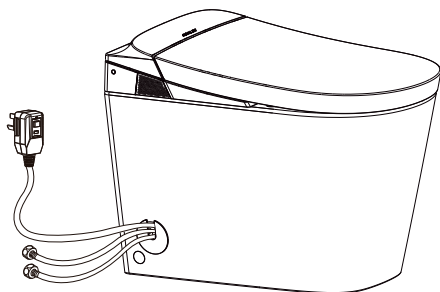

Connect the inlet water valve

- Check whether or not the inlet water valve and power supply have been turned on.
- Check whether or not batteries have been loaded into the remote control.
- Make sure there is no any obstacle in front of the product.
- Wait until the main unit completes the self-test. It is normal that motor rotation sounds and water flow sounds can be heard during this period.

- When used for the first time, the product has factory settings.

Front wash:

- Water temperature: medium
- Spray intensity: medium
- spray position: middle
- Pulsating mode: off

Ring temperature: medium

Energy saving: off

Automatic flip function: open

Microwave induction distance: medium

Automatic flushing function: flushing

Night light: on

Rear wash:

- Water temperature: medium
- Spray intensity: medium
- spray position: middle
- Pulsating mode: off
- Thermal cycling : off

Automatic UV sanitation: on

Automatic deodorization: on

Long sitting reminder: off

Automatic temperature adjustment

function of water temperature circle: off

Foot sensor function: on

Clean foam function: on

The aforesaid settings are available for the model with complete functions. Refer to the product configuration table for different specifications of various models.

# Cover/Seat OPEN/CLOSE function

## A. Cover OPEN/CLOSE

- Auto cover OPEN, CLOSE

When cover is CLOSE, user enters sensor area, cover auto opens.

When cover is OPEN, user leaves sensor area, cover auto closes after a period of time.

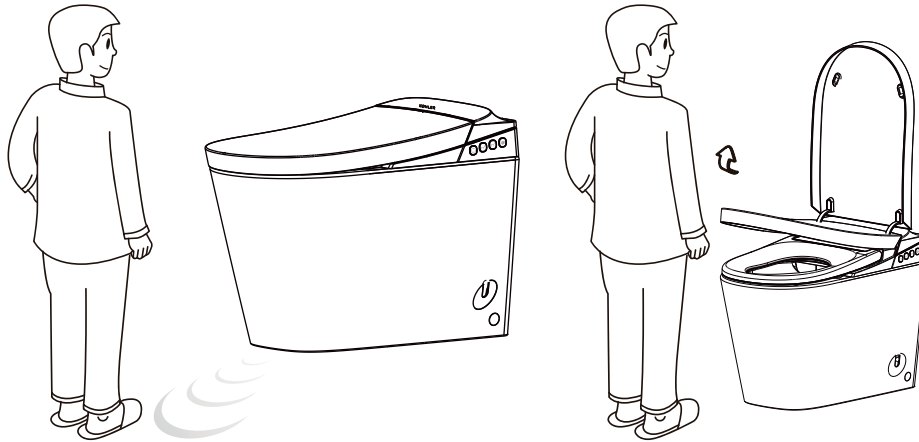

- Cover OPEN and CLOSE by remote

When unseated, press Cover button on remote, perform corresponding OPEN/CLOSE function (details are shown in the diagram of remote). When seated, press Cover button on remote will be invalid.

- Manual cover OPEN and CLOSE

User could manually OPEN/CLOSE cover. When users intend to open or close the cover under normal condition, the cover can open or close automatically against the trend of motion. Users will not have to use force. Once being stopped by any obstacle during motion, the cover will automatically stop moving.

**Attention:**

1. When customer enters sensing zone slowly, cover OPEN/CLOSE sensing distance might be shortened. If there's no response, OPEN/CLOSE cover by remote or by manual mode.
2. Auto cover OPEN/CLOSE function will be valid when remote "Cover OPEN/CLOSE" function set to "ON" (see remote control user guide).
3. Do not place any moving obstacle 60cm in front of toilet tip, if there is one, cover might auto open. Refer to remote control user guide.

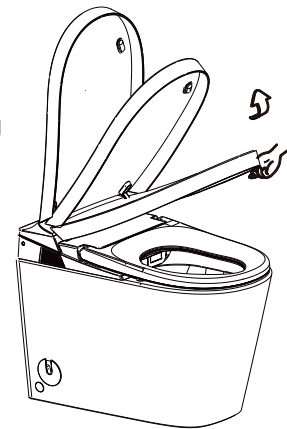

## B. Seat OPEN/CLOSE

- Seat OPEN and CLOSE by remote

When unseated, press Seat button on remote, perform corresponding OPEN/CLOSE function (details are shown in the diagram of remote). When seated, press Seat button on remote will be invalid.

- **Manual seat OPEN**

User could manual OPEN/CLOSE seat. When users intend to open or close the seat under normal condition, the seat can open or close automatically against the trend of motion. Users will not have to use force. Once being stopped by any obstacle during motion, the seat will automatically stop moving.

**Note:**

Do not use excessive force etc. human related factor when OPEN/CLOSE the cover/seat during cover/seat open/close process.

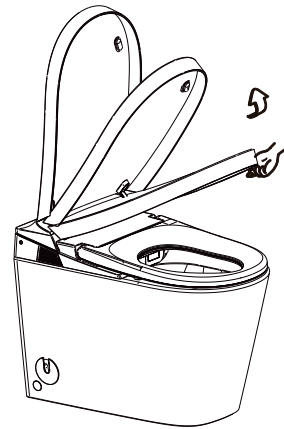

## Flushing your toilet

### A. Auto flush function

#### a) Seat usage

When cover is OPEN and toilet is in use. Toilet will auto flush after unseated for a certain time. Close seat within a period of time.

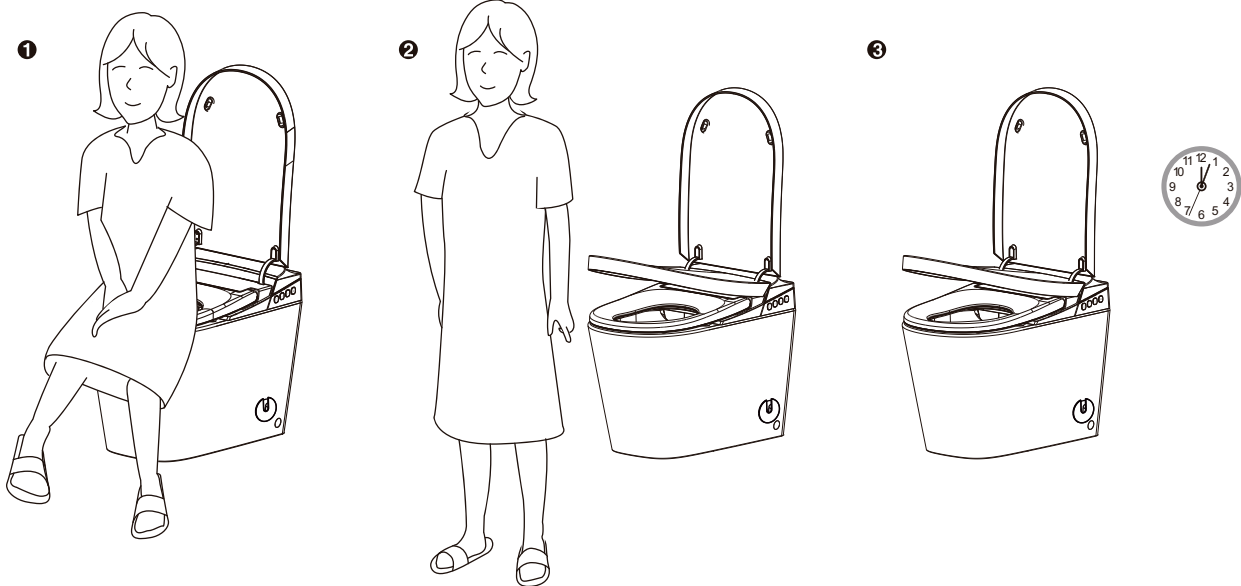

## b) Formale use

When cover is OPEN and toilet is in use, Toilet will auto flush after unseated for a certain time. Auto close seat/cover after a period of time.

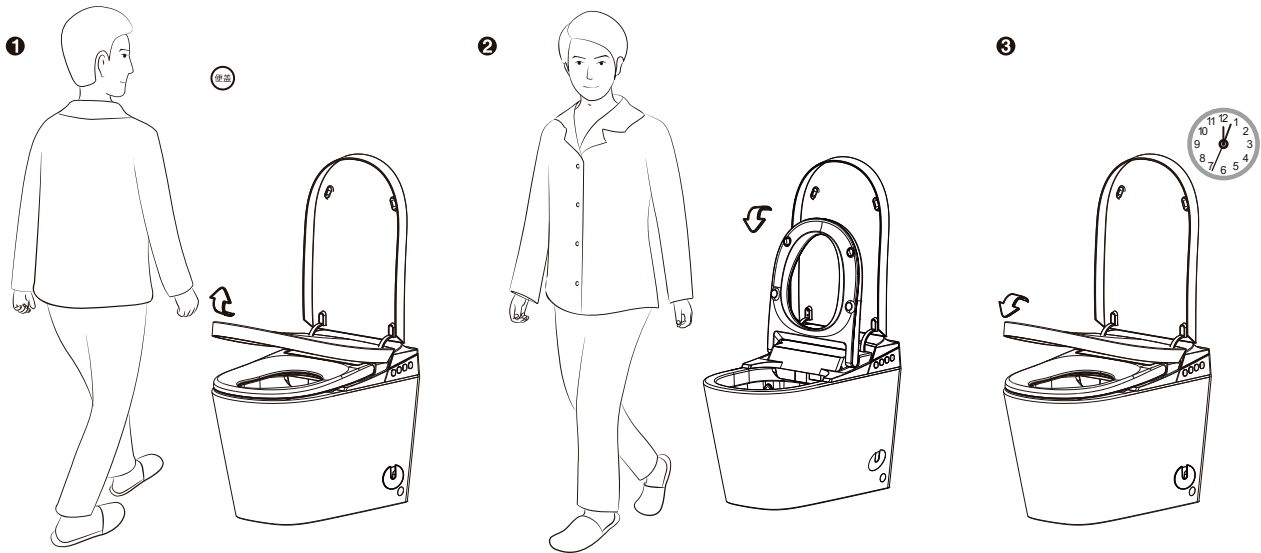

### Note:

1. If auto flush function is OFF, customer shall use remote to control flush, manual flush toilet or use basin to flush the toilet.
2. Only when the "Automatic flushing" on the remote control is set to "On," then the automatic flushing feature is enabled. (See remote control user guide for the setting method.)

## B. Remote control flush

Customer shall press flush button on remote to perform toilet flush function.

Note: remote flush function shall not perform second auto flush within 60s.

## C. Press side panel to flush the toilet

Customer could press flush button on side panel to flush the toilet.

## D. Emergency flushing

During an outage, you can connect the spare battery pack(machine parts), and press and hold the Flush key on the side keypad to perform flushing.

- 1.Remove the ceramic cover and pull out the cable from the buckle behind the ceramic cover.
- 2.Connect the waterproof DC power plug and tighten the waterproof cap.
- 3.Put the battery pack in the appropriate position, as shown in the figure.
- 4.Cover with ceramic cover.

Note: Distinguish the positive and negative ends of the battery and cable. Be sure of no forcible insertion. Otherwise, the product will be broken as a result.

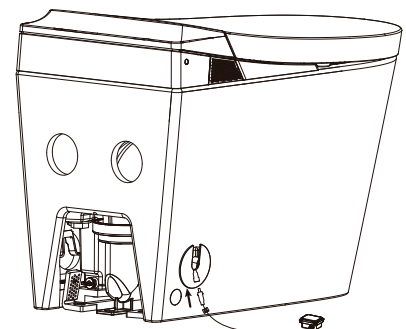

## Clean foam function

### A. Automatic foam cleaning function

#### a) Usage of seat rings

When the lid is open, the toilet will automatically foam after the user sits down.

#### b) Men's urination condition

When the lid is open, the toilet seat will automatically foam after the user manually or remotely flips up the seat ring.

Note: 1) The automatic foam cleaning function will not perform a second automatic foaming within 20 minutes.

2) The automatic foam cleaning function is only effective when the remote control's automatic foam cleaning function is set to "on" (see the remote control user guide for setting methods)

### B. Remote control for foam cleaning function

Long press the Rear Wash button to activate the manual foam cleaning function.

## Foot sensor function

Touch the sensing area with your feet to open/close the ring/cover and flush water. In the seated state, foot sensation is ineffective.

Feel your feet → Open the lid → Feel your feet → Open the circle → Feel your feet → Flush  
→ Feel your feet → Close the lid and seat

When the product is set to the closed lid flushing mode and in the open loop state, feel your feet and close the loop+close the lid+flush.

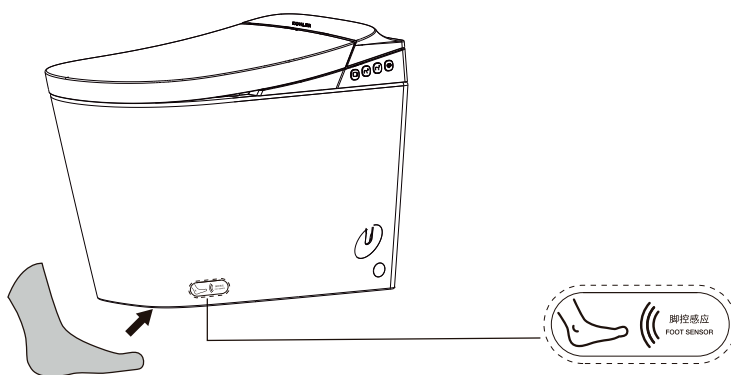

Note: 1. The foot sensing function is only effective when the foot function of the remote control is set to "on" (see the remote control user guide for setting methods).

2. The lid closing flushing function is only effective when the "Microwave Settings" in the remote control is set to "On".

## Auxiliary keyboard function

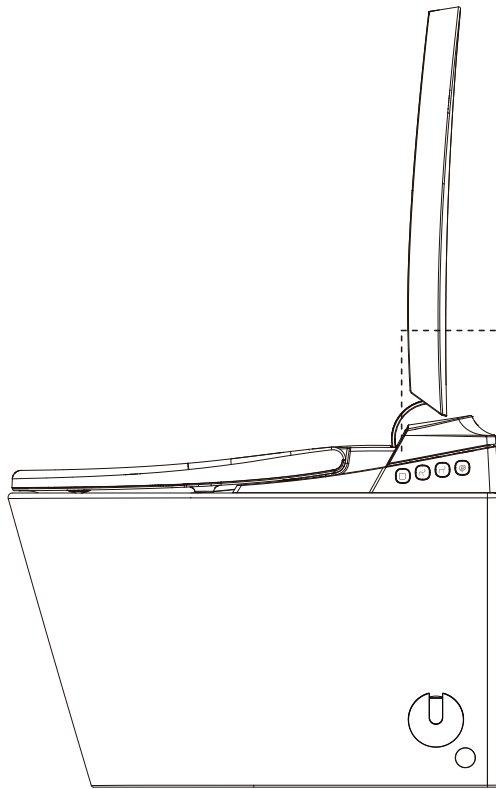

1. Standby mode  
Long press STOP button more than 2s to start standby mode, detailed information refers to "Standby mode" on page 18.

2. Stop function  
Press STOP button to stop the ongoing flushing, drying, deodorization, manual spray wand cleaning or UV/Clean foam function.

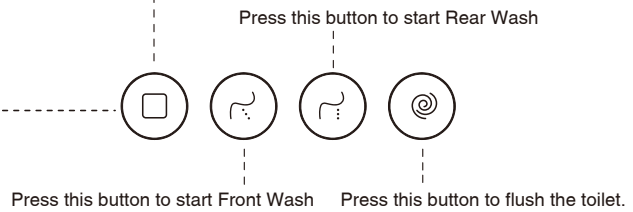

### Note:

1. All functions following factory default setting.
2. When use Front Wash /Rear Wash, start corresponding functions and auto stop after 5min.
3. Use STOP button to stop Front Wash/Rear Wash/Dryer/Deodorization/Manual Spray Wand Cleaning/UV Function/Clean foam .

## Standby mode

1. Press and hold the “” key (for more than 2 seconds) to start Standby mode. Then, the automatic sensing and remote control will be disabled, and the seat ring heating will stop so as to minimize energy consumption.
2. When press any button on side panel or seated, auto exit standby mode, all function recovered.

## UV sterilization function\*

1. UV function is used to sterilize the nozzle by UV.
2. Auto UV sterilization
  - When toilet is not in use for a long time, auto UV sterilization function will start and begin to sterilize nozzle. No sterilization function shall be activated after this process in another 24hours.
  - During UV sterilization process, if customer open cover and start use toilet, or presses STOP button on remote, UV sterilization function will be stopped.
  - Auto UV sterilization function setting refer see remote control user guide.
3. Manual UV sterilization
  - When unseated, press “sterilization” button on remote to start UV sterilization function (details are shown in the diagram of remote control).
  - During sterilization process, if customer open cover and start use toilet, or presses STOP button on remote, UV sterilization function will stop.

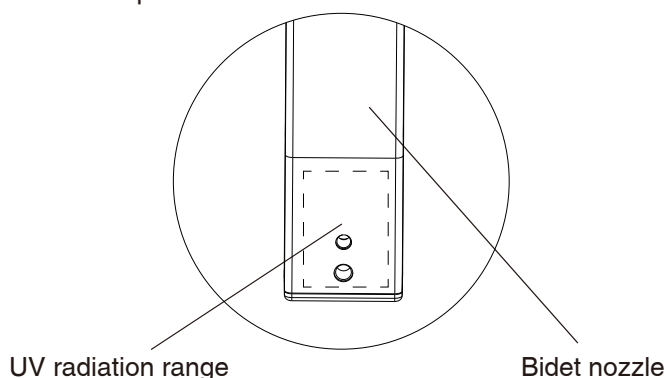

\* UV sterilization (refers to the ultraviolet sterilization generated by UV lamp): During UV working cycle, the bacteria on nozzle surface will be eliminated by irradiation. The antibacterial rate is more than 99%. (Measured after one UV working cycle, it was measured within 16mm×8mm irradiation area. Perform test in accordance with GB /T 23131 requirements, UV radiation zone was shown in the diagram, UV working cycle activation mode refers to users guide. Testing lab: SGS)

## Energy saving function

- When energy saving is enabled, the general energy saving will reduce the toilet heating temperature and the comprehensive energy saving will directly turn off seat ring heating to achieve the purpose of energy saving.
- Refer see remote control user guide for energy saving setting.

## Deodorizer

When unseated, auto starts deodorizer function.

Press “” button on side panel or remote to stop deodorization feature.

## Prolonged seating indication

When prolonged seating indication feature is activated, the system will alert customer by buzz when customer sits on the toilet over a long period of time.

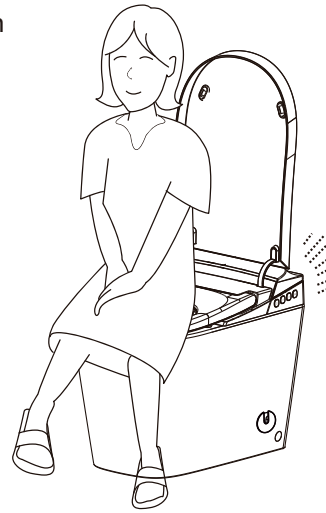

## Water temperature/seat temperature auto adjustment feature

When water temperature/seat temperature auto adjustment function is activated and water temperature/seat temperature set to auto adjustment setting (with the indicator light L3 on), the toilet will auto adjust water temperature/seat temperature to corresponding setting.

## Maintenance and cleaning

### A. Normal cleaning

For the best effect, remember the following rules during maintenance of your Kohler product:

Important! Do not flush the cover directly by water (including remote controller)

- 
- Do not immerse in cleaning solution. Do not immerse the product in cleaning solution.
- Avoid using materials that will damage the surface-Clean the surface with a soft and wet sponge or cotton cloth, instead of materials that can damage the surface.
- Scrubbing - After adding the cleaner, use a wet towel to scrub the surface immediately to remove cleaner or dirt sprayed to the surface.

### Cleaning the seat

- Do not use abrasive cleanser or sanitizer inside the spray tank for cleaning.

**Maintenance:** In case of using a mixture of washing agent and water as well as any available solution for seat cleaning, use soft and wet sponge or towel to clean the seat. Use a soft towel to make the seat dry, or let it dry naturally.

- Corrosive chemicals or cosmetics (such as nail polish or aftershave) should not come in contact with these at as this will damage the surface.

### Clean stainless steel beauty parts

- Clean surface with neutral soap water, then wipe entire surface with clean soft rag. Many detergents such as ammonia water, decontamination powder and detergent etc. will cause surface damage. Do not use.

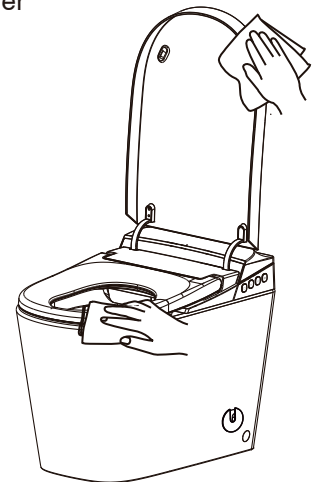

Note: fail to observe cleaning instruction will void the Kohler warranty.

Note: The success of the cleaning process depends on the water hardness and temperature, the dose precision of composition, cleaning regulation variation and cleaning product status etc. factors. Kohler can't ensure the validity of rules since these factors may change.

Note: when clean opened seat, do not apply excessive force to avoid any product damage.

## B. Nozzle Clean

Method used for nozzle cleaning by soft brush.

- When unseated, and press and hold the Forward key on the remote control. Then the spray wand will draw out.
- Use a wet soft brush to clean the nozzle.
- Press and hold the Backward key or the Stop key to make the spray wand draw back, or the spray wand will automatically draw back in 5 minutes.

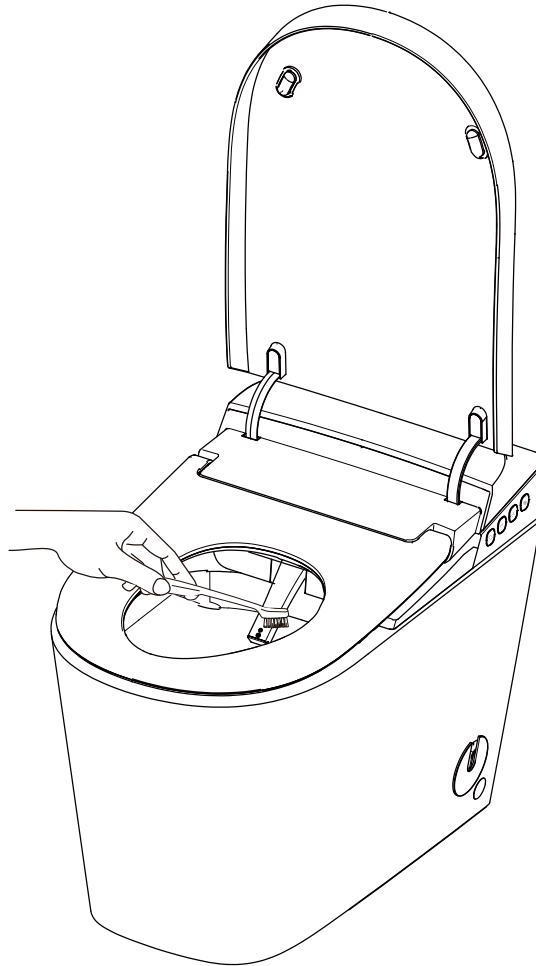

## C. Cleaning or Replacing the Filter

Clean or replace the filter if there's not enough water volume or water is not coming out.

### Cleaning the toilet filter

- Turn off inlet water supply.

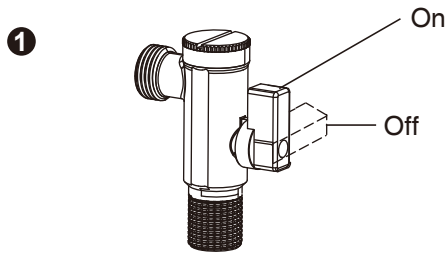

Turn off stop valve

- Use a 1-yuan coin to turn the filter counterclockwise to open the filter.
- Take out filter and clean it.

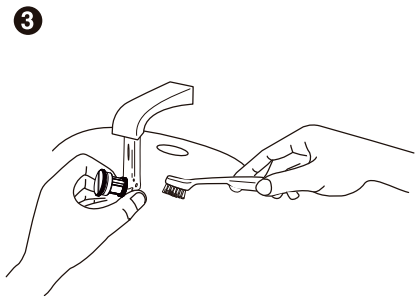
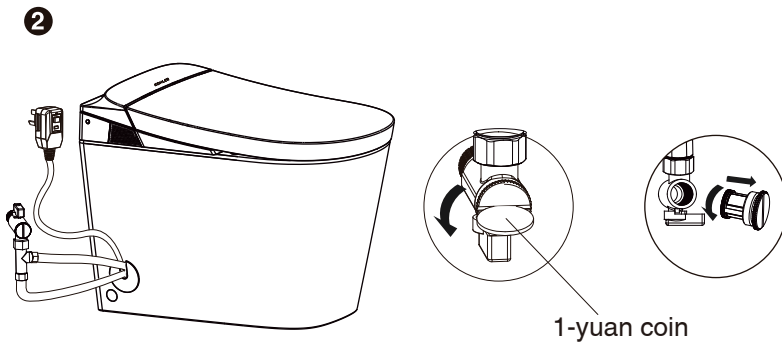

- Reinstall filter and turn stop valve on.
- Inspect joint for any water leak, then plug power cord.

**The steps to replace filter are the same as the above steps.**

Notes:

If filter is found broken or serious blocked, please replace it in time.

## D. Replacement of deodorization module

When users find that the deodorizing effect is not obvious and feel a strange odor, please replace the deodorizing block in a timely manner.

Steps for removing the deodorization module:

Remove the deodorizing louvers and deodorizing blocks, replace the deodorizing blocks, and then put them back in place.

Note: After removing the deodorizing block, do not put your hands or other objects into the chamber of the deodorizing block to prevent damage to the fan and other components.

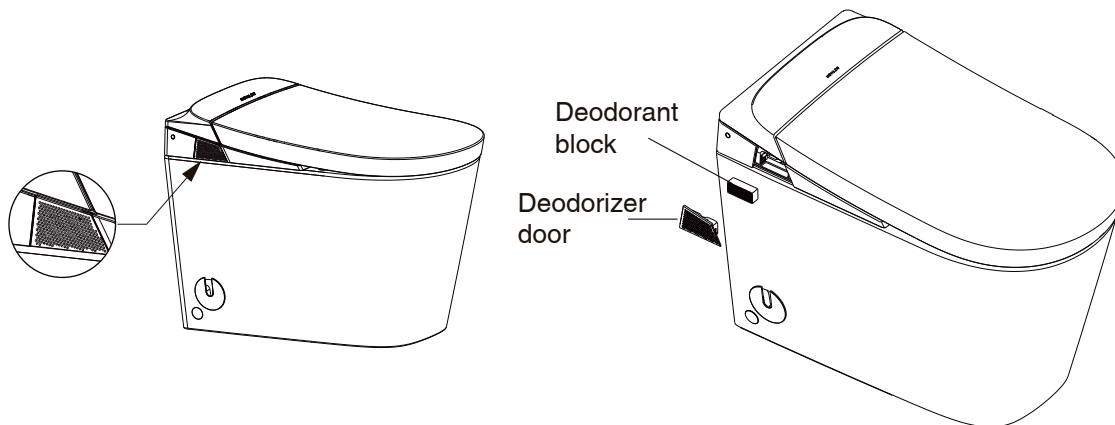

Scan the code to view the replacement and deodorizing block model: 33998T-NA.

## E. Addition of foam concentrate

After using it for a period of time, the user found that the foam volume of the foam cleaner function was significantly reduced, so the foam liquid should be replenished in time. The specific steps are as follows.

1. Turn off the power or refer to the "Remote Control User Guide" to turn off the automatic flip cover function.
2. Lift up and remove the decorative cover plate.
3. Press and remove the liquid filling cap.
4. Open the cap of foam solution bottle, align it with the filling port, and slowly pour in foam solution  
Note: One bottle of liquid should not be added at a time (with a storage tank capacity of 470ml), otherwise it may overflow.
5. Put the liquid filling cover back into the liquid filling port, and then reinstall the decorative cover plate in its original position.
6. Turn on the power or refer to the "Remote Control User Guide" to restore the automatic flipping cover function.
7. When using for the first time, long press the "Weak" button of the remote control, and then short press the "Massage" button to perform the foam liquid suction operation.

Scan the code to check the replacement, foam liquid model: 39128T-NA.

## F. Maintenance in case of long-term idle status

a) If the intelligent toilet will be idle for a long term, make sure the water in pipeline of cover is drained completely.

- Unplug power supply, close angle valve.

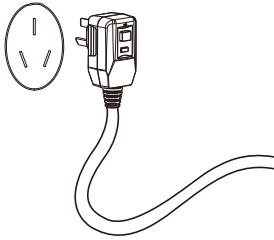

pull the plug

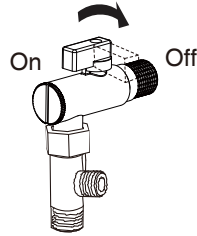

Close the angle valve

### Note:

1. If the water in the water tank is not drained and the product is not used for a long time, the residual water is likely to freeze in winter and deteriorate in summer.
2. If you find the water supply pipe has been frozen, do not use the intelligent cover. You will need to raise the room temperature and use it after the water is thawed.
3. In winter, when there is a risk of water pipe freezing, close the angle valve and make the toilet flush once or drain the water in the toilet.
4. In case of long term idle status, remove the batteries in the charging block of remote control.
5. Open cover or add water inside the toilet might avoid the plastic parts yellowing problem caused by backflow air from discharge pipe after residual toilet water evaporated during long-term idle status.

# Trouble shooting

This guide of trouble shooting is for general help only. Authorized representatives or qualified electricians of Kohler Company shall be able to solve all electrical failures. If you want to know about the service of warranty, please contact local dealers or wholesalers.

Symptoms	Possible Causes	Recommended Actions
1. Toilet does not work	A. Power failure B. Plug not connected or no power to socket C. The leakage circuit breaker on plug does not reset D. Product is on standby mode	A. Wait until the power is restored B. Plug in or detect the socket C. Press Reset button on the plug D. Press “⊖” button at the side panel
2. The toilet does not flush	A. Water failure B. Tee valve for water supply is closed C. Power failure D. Product is at standby mode E. Wash mode is in progress F. Auto-flushing is deactivated	A. Wait until the water supply is restored B. Open the tee valve for water supply C. Wait until the power is restored or review manual flush, manual flush or flush by using the basin D. Press “⊖” button at the side panel E. Perform after flushing operation completed F. Review “Remote Control user guide”
3. Wash mode is abnormal	A. Water failure B. Tee valve for water supply is closed or not opened completely C. Not yet seated or current sitting posture unable to be sensed by the seat D. Filter screen or filter element clogged E. Insufficient water pressure	A. Wait until the water supply is restored B. Fully open the tee valve for water supply C. Seated or adjust your sitting gesture D. View the section on "Cleaning the filter screen or replacing the filter element" E. Check bend problem on inlet hose, if so, adjust hose
4. Flush function stops in operation process	A. Flushing mode stops automatically after continuous flushing for 5 minutes B. The seat is unable to sense human body	A. If necessary, press the flushing button again B. Adjust your sitting gesture or sit on the toilet again
5. The wash mode runs even when unseated	A. The seat is covered by foreign matters or the seat is wet	A. Remove the foreign matters or dry seat
6. Dryer fan stops in operation process	A. The dryer fan stops automatically after continuous usage for 4 minutes B. The seat is unable to sense human body	A. If necessary, press the dryer button again B. Adjust your sitting gesture or sit on the toilet again
7. Deodorization fan does not work	A. Stop button is pressed by mistake during operation B. Automatic deodorization disabled	A. If necessary, please unseat for about 2S and then sit on the toilet again B. Review “Remote Control user guide”
8. Cover fails to close/open	A. The seat is covered by foreign matters or the seat is wet B. The toilet cover is interfered by people at the open/close process before	A. Remove the foreign matters or dry seat B. Use the remote control or manually open/close the cover until it works properly. Do not block switch during open/close process
9. Auto cover fails to close/open	A. User is not seated enters or leaves the sensing area B. Remote controller “automatic cover-turning” function is deactivated C. The toilet is in the process of flushing	A. Please sit or leave the sensing area B. Review “Remote Control user guide” C. Wait until the flushing process is completed
10. Intelligent deodorization not work	A. User sits on the toilet B. The seat is covered by foreign matters or the seat is wet	A. Please close the cover and reactivates the UV sterilization again when unseated B. Remove the foreign matters or dry the seat
11. Remote not work	A. Battery exhausted B. Battery polarities are mounted reversely	A. Replace with new batteries B. Reinstall properly

<p>12. Remote control fails to connect to toilet</p>	<p>A. Lower battery  B. The remote control is too far from the toilet  C. The toilet is not powered up  D. The toilet is on standby mode  E. The toilet is not connected to the remote control</p>	<p>A. Review "Usage and replacement of battery for remote control" chapter and replace battery accordingly  B. Review "Communication between remote controller and the toilet", and approach to the toilet  C. Power on the toilet  D. Press "⊖" button on side panel or seated  E. Review "Communication between remote and toilet" and connect toilet and remote accordingly</p>
<p>13. The seat is not warm</p>	<p>A. Remote seat temp set too low  B. Toilet is on standby mode  C. The system enters the energy saving mode</p>	<p>A. Set seat temp to proper dial  B. Press "⊖" button at the side panel  C. Exit Energy saving mode, refer to the "Remote control setting instructions" section</p>
<p>14. The night light is not on</p>	<p>A. The night light function is turned off  B. The indoor lighting is too bright</p>	<p>A. Refer to the Night Light section in the "Remote controller setting guide" to activate the night light function  B. Please completely cover the photosensitive window</p>
<p>15. When activating the foam cleaning function, foam discontinuous</p>	<p>A. When activating the foam cleaning function for the first time, inside the liquid storage tank There is air exclusion  B. Just finished using the flushing function, the toilet is still being refilled water state  C. The foam fluid in the fluid reservoir of the machine is exhausted</p>	<p>A. This is a normal phenomenon, and after starting it multiple times, this phenomenon will be eliminated.  B. Please wait for the toilet to replenish water before activating the foam cleaning function.  C. Timely replenish foam liquid.</p>

## Description of Content of Hazardous Substances in Product

### Reclaim Indication

When the product exceeds service life or is unable to use after repair, do not throw the product away in the normal trash. Please dispose the waste electronic parts through a qualified reclamation enterprise. Make sure the product is handled properly. Disposing of product must be done in accordance with the local or national government law.

### Statistics of Contents of Toxic or Hazardous Substances or Elements

Part name	Toxic or Hazardous Substance or Elements									
	Lead (Pb)	Mercury (Hg)	Cadmium (Cd)	Hexavalent Chromium (Cr(VI))	Polybrominated biphenyls (PBBs)	Polybrominated Diphenyl Ethers (PBDEs)	Phthalic acid Di-n-butyl acetate (DBP)	Phthalic acid Di-n-butyl acetate (DIBP)	Phthalic acid Butyl benzyl ester (BBP)	Phthalic acid Acid di (2-ethyl) Hexyl ester (DEHP)
Plastic Assy.	○	○	○	○	○	○	○	○	○	○
Control Assy.	X	○	○	○	○	○	○	○	○	○
PCBA Assy.	X	○	○	○	○	○	○	○	○	○
Motor Assy.	X	○	○	○	○	○	○	○	○	○
Wire Harness Assy.	○	○	○	○	○	○	○	○	○	○
Water Inlet Assy.	○	○	○	○	○	○	○	○	○	○
* Wand Assy.	○	○	○	○	○	○	○	○	○	○
Heater Assy.	X	○	○	○	○	○	○	○	○	○
* Remote Assy.	X	○	○	○	○	○	○	○	○	○
* Battery	○	○	○	○	○	○	○	○	○	○
* Ceramic Assy.	○	○	○	○	○	○	○	○	○	○
* Water Tank Assy.	○	○	○	○	○	○	○	○	○	○

Note1: ○: Indicates that the content of this hazardous substance in all homogeneous materials of this component does not exceed the requirements of the national standard for the restriction of the use of hazardous substances in electrical and electronic products.

X: Indicates that the content of this hazardous substance in at least one homogeneous material of this component exceeds the requirements of the national standard for the restriction of the use of hazardous substances in electrical and electronic products.

Note2: For components not listed above, it indicates that their hazardous substance content does not exceed the requirements of the national standard for the restriction of the use of hazardous substances in electrical and electronic products.

\* : Indicate only partial product series contains this substance.

Note: the information provided is based on the supplier data and Kohler inspection results. The product is designed not to hurt the environment. Under current technology, all hazardous materials have been used in the smallest amounts possible. Kohler will strive to reduce the use of these hazardous materials used in this product.



The product "service life for environment protection" is 10 years; Kohler company will specify product service life based on product characteristics. The product "service life for environment protection" is only effective when the product is used as described in the product specification.

## 感谢您选择科勒公司

感谢您选择科勒。科勒技术提供了可靠性能和优雅生活的结合，满足了您未来几年的需求。科勒产品的美观和可靠性将满足您最挑剔的眼光。我们为我们科勒的产品感到非常地自豪，相信您也会。

请花几分钟阅读一下这本用户手册，特别注意维护和清洗说明。

这本说明书中所有的信息基于最新公开的产品信息。在科勒，我们一贯坚持改善我们产品的质量。我们保留在任何时候不通知的情况下改变产品特性，包装或实用性的权利。

# 目录

感谢您选择科勒公司 .....	27
安全注意事项 .....	29
规格 .....	31
整体简图 .....	32
遥控器使用指南 .....	33
遥控器设置指南 .....	34
初次使用前准备 .....	36
便盖/座圈开关功能 .....	37
便器冲水 .....	38
绵净泡功能 .....	40
脚感感应功能 .....	40
辅助键盘功能 .....	41
待机模式 .....	42
UV 除菌功能 .....	42
节能功能 .....	42
除臭 .....	42
长时如厕提醒功能 .....	43
水温圈温自动调节功能 .....	43
维护和清洗 .....	43
疑难解答 .....	48
产品中有害物质含量的说明 .....	50

## 安全注意事项

- 如果电源软线损坏，为了避免危险，必须由制造商、其服务机构或类似的专业人员更换。
- 最小进水压力0.07MPa(动压)，最大进水压力0.74MPa。
- 必须使用随器具附带的新软管组件，旧软管组件不能重复使用。
- 本产品必须安全接地。只能连接到专用的220V~，50Hz，10A带接地故障断路器或接地漏电保护器的电路中。

## 警告

 **警告：**如果无视此标志内容而误操作时，有可能造成人员重伤或死亡。

- 在通电之前必须按照说明书中的要求接地。
- 在安装本坐便器时切勿使用任何凝胶材料（水泥砂浆）。因为凝胶材料（水泥砂浆）的热膨胀可能使坐便器的脚部挤破或损坏。科勒对所有因为凝胶材料（水泥砂浆）安装而引起的坐便器破裂恕不负责。
- 提防损坏产品。请不要向便器内冲入新闻纸、纸尿裤、妇用卫生巾等容易堵塞的物品。请不要用重力撞击陶瓷，以防止破损漏水。不要在0℃以下的环境中使用。
- 触电或产品损伤的危险。不要把产品浸入水中。
- 产品损坏的危险。在安装工作完成之前不要接通电源，这可能导致产品故障。
- 当使用电器产品时，尤其当儿童在场时，应该遵守基本的安全防范，包括如下：  
**危险-降低触电的危险：**
  - 不要把此产品放置在可能掉落或可能被拉入浴缸及水槽的地方。
  - 不要放置或掉到水及其他液体中。
  - 不要触及掉进水中的产品，请立刻拔掉电源插头。
- 如果有以下情况请不要使用本产品：电源线、插头及产品有损坏；产品不能正常工作；产品掉入水中。
- 使电源线远离加热表面。
- 防止将水淋到电源插头上。

## 注意

 **注意：**如果无视此标志内容而误操作时，有可能造成人身伤害或产生损失。

- 遥控器只允许在坐便器视线之内控制器具。
- 产品损伤的风险。不要安装在水可能溅到的地方。
- 产品损伤的风险。不要把产品安装在过分潮湿的地方，在这种地方，水汽可能凝聚在产品表面。请始终保持使用环境有足够的通风，以防止电子组件的损坏。
- 产品损坏或财产损失的风险。硬推、硬拉水管接头可能造成水渗漏。
- 产品损坏的风险。不要在喷嘴上施加过大的力，否则产品可能损坏。
- 产品损坏的风险。在一些水可能在水管中结冰的地方，要做好水管保温的安排。任何留在产品里的水在冬天储存时都可能结冰。在重新安装或使用前请保证产品暖至室温。
- 温暖的气候时，热保护器在存储或运输过程中可能失灵，导致产品不工作。在重新安装或使用前请保证产品冷至室温。

## 安全注意事项（续）

### 警告—避免低温灼伤、触电、火灾或人身损伤

- 当儿童、老年人、残疾人，以及身体、感知、智力能力缺陷或经验和常识缺乏的人使用或靠近此产品时，近距离的监护是必需的。儿童不应该被允许使用或接触此产品，不要让儿童独自待在安装有此产品的房间，儿童不应玩耍器具。
  - 对于无法自己进行温度调节操作的儿童和老人，需要帮助将坐便盖的圈温、冲水温度及风温调节到合适的档位。
  - 请避免长时间让裸露的皮肤接触加热座圈，以免低温灼伤。
- 仅按照手册中所描述的方式使用本产品，不要使用科勒不推荐的附件，如角阀等。
  - 使用时请勿倚靠在盖板上，以免损坏产品。
  - 根据安装说明正确地安装本产品。
  - 只有专业人士可以修理此产品。不要试图自己维修此产品，否则保修无效。
  - 在安装本产品的同一房间中，需要在触手可及的位置安装一个止水阀，用于紧急情况下，无需借助工具即可切断本产品的进水水路；否则本产品的意外故障可能会导致用户损失。
  - 不要把任何物品掉入或插入管路和开孔处。
  - 不要在户外或者微粒喷雾设备正在被使用的地方使用本产品。也不要给氧的地方使用本产品。
  - 需要有资质的维修人员维修紫外线杀菌装置。
  - 必须使用随器具附带的新软管组件，旧软管组件不能重复使用。
  - 用户切断电源后，如须再次接通电源，请务必听到“滴...”提示音结束后，再接通电源。
  - 如果发现下列情况，请勿继续使用。请断开电源并同时关闭进水角阀，停止供水。
    - 软管及产品的内部向外漏水。
    - 当产品出现裂缝或破损时。
    - 产品出现异声或明显异味。
    - 发现产品产生烟雾。
    - 当产品异常发热时。
  - 不同类型的电池或新旧电池不应混合使用。
  - 非充电电池不要充电
  - 用尽的电池需要从器具中取出并安全处理
  - 如果设备长期存放不用，应拆卸电池
  - 电源端子不能短路
  - 遥控器不能放置在被水淋到的地方
  - 不要在水箱及陶瓷内部添加漂白剂、防腐剂、清洁剂、化学物质，可能会对水箱及陶瓷内的部件和管道造成损害。

规格			
冲水用水量	4.0L		
水效等级*	2级		
使用坑距	305/400mm		
供水压力	最小进水压力0.07MPa (动压) 最大进水压力0.74MPa		
额定电压	220V~, 50Hz		
额定功率 *	1040W		
电源线长度	总长约1.5m, 外露陶瓷部分约1.2m		
产品外型尺寸	约680mm x 368.7mm x 506mm		
产品重量	约40kg		
进水温度	1-35°C		
使用环境温度	1-40°C		
清洗	臀部冲洗	有, 档位可调	
	女性冲洗	有, 档位可调	
	出水流量(水压0.2MPa时)	臀部冲洗最大档不小于500mL/min	
	清洗水温调节	关、低、中、高三档可调/自动档(仅水温圈温自动调节功能开启时可用)	
	冲洗时间 (最长)	约300s	
	喷嘴位置调节	3档	
	脉冲按摩	开/关	
	移动冲洗	开/关	
	冷热交替 (仅臀洗)	开/关	
	安全装置	水温过热保护	温度保险丝
逆流防止		单向阀、真空破坏器	
舒适	座圈保温	温度调节	关、三档可调/自动档(仅水温圈温自动调节功能开启时可用)
		安全装置	温度保险丝
	盖板	自动开合、缓降、遥控开合	
	座圈	缓降、遥控开合	
	暖风	暖风功能	有
		安全装置	温度保险丝
	除臭功能	有	
遥控器	有, 功能参考“遥控器使用指南”		
卫生	喷嘴自清洗	有	
	抗菌材料	坐圈/整机外壳/上盖 (科勒白) /装饰盖 (科勒白)	
	UV除菌	有	
其它功能	其它安全装置	漏电保护器	
	辅助键盘	有	
	落座感应	位于座圈内部	
	自动开关盖	微波感应	
	紧急冲水	有	
	夜灯	有, 仅用于坐便器内部照明, 不具备外部照明功能	
	脚感感应功能	有	
绵净泡功能	有		

\*智能坐便器施加的水效标识的说明: 水效标识表示智能坐便器水效等级等性能的一种符合性标志。

\*功率值测试条件: 动压0.2MPa, 进水温度15°C。

以上参数为全功能版本, 具体型号的规格差异见产品配置表。

# 整体简图

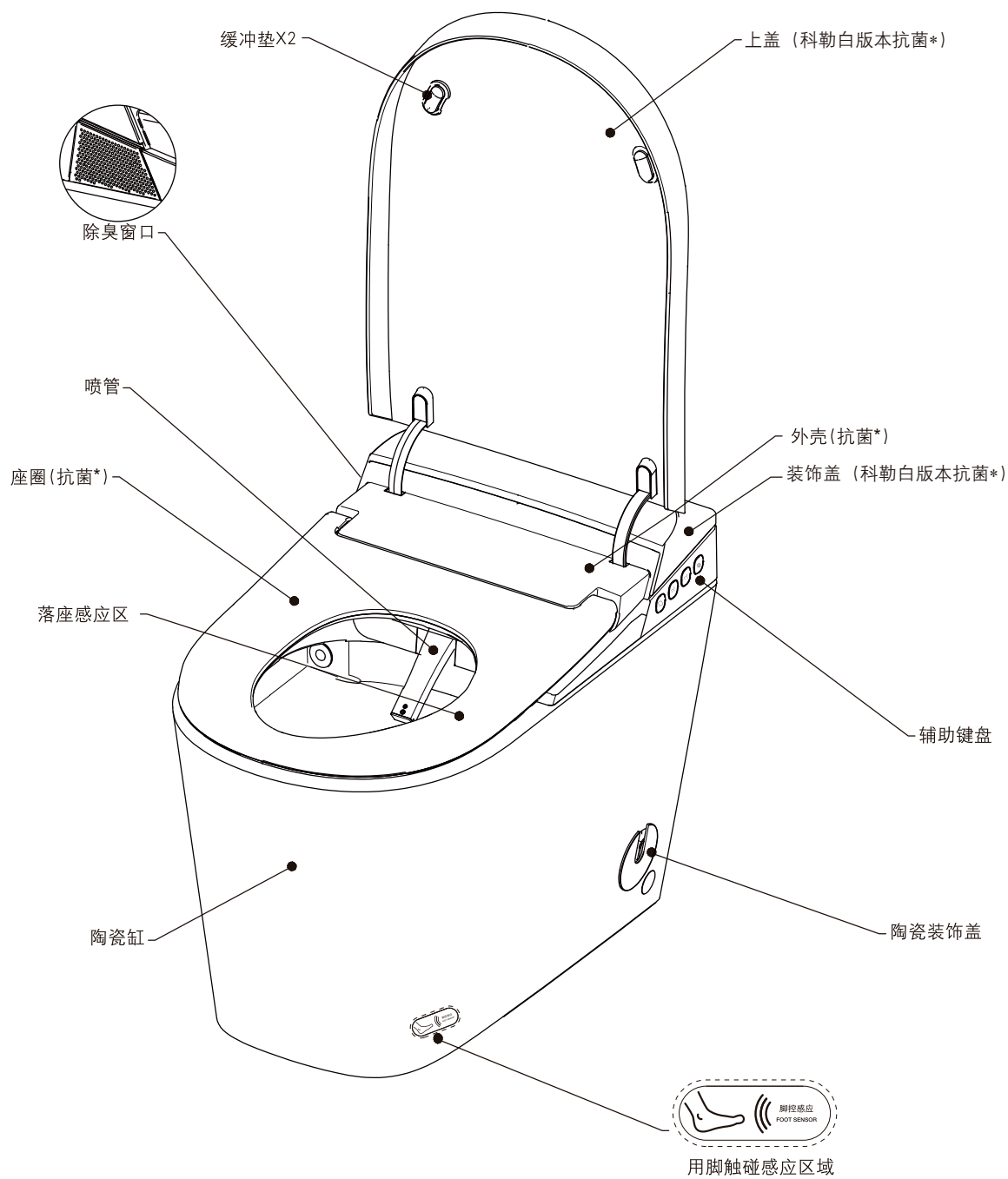

\*抗菌：含无机系抗菌材料的座圈长期抗细菌，抑制产品表面的细菌生长，这一加工处理不代表防霉等附带效果。抗菌率大于90%（依据GB21551.2-2010进行试验。测试机构：中国家用电器检测所、上海出入境检验检疫局机电产品检测中心）

# 遥控器使用指南

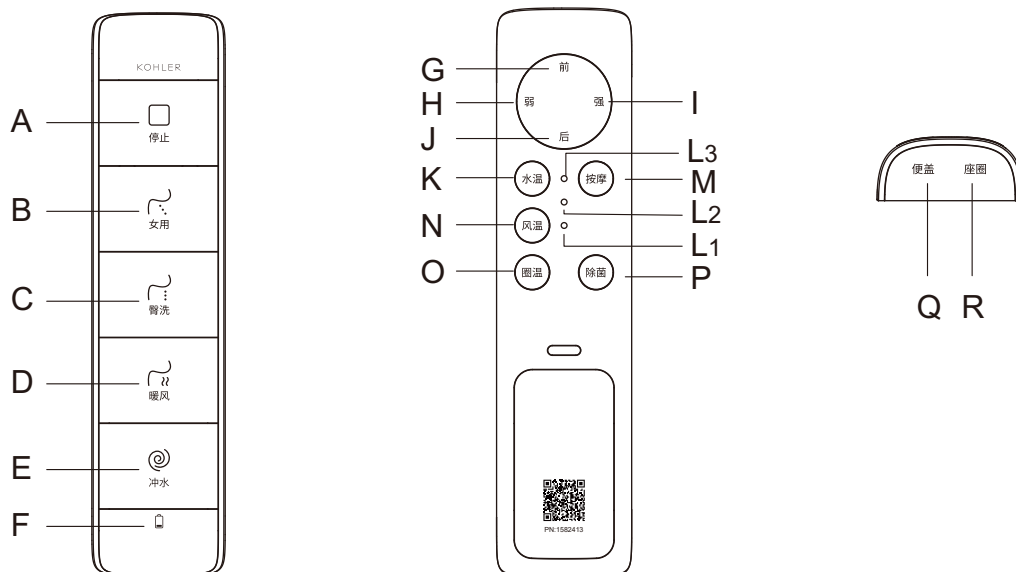

**注意：**为避免掉落的风险，请从支架上取下遥控器再进行操作（非防遗失安装方式）。

## A - 停止

- 按此键可停止女用、臀洗、暖风、除臭、手动清洗喷管、除菌、绵净泡发泡功能。

## B - 女用

- 落座后，按此键开启女性冲洗，约5分钟后自动停止或按停止键立即关闭。

## C - 臀洗

- 落座后，按此键开启臀部冲洗，约5分钟后自动停止或按停止键立即关闭。
- 长按此键开启手动绵净泡功能。

## D - 暖风

- 落座后，按此键开启暖风功能，约4分钟后，自动停止或按停止键立即关闭。（风温有四档，指示灯全灭为常温）

## E - 冲水

- 按此键对坐便器缸体进行冲洗。

## G - 前

- 按此键调节喷管位置向前移动，喷管位置有三档。
- 离座状态下，长按此键喷管伸出，进入手动清洗，此功能用于对喷头进行手动清洗。按“停止”键停止该功能。

## J - 后

- 按此键调节喷管位置向后移动，喷管位置有三档。

## H - 弱

- 按此键减弱清洗强度。
- 长按此键，再短按“按摩”键进行泡沫液吸液操作。

（注：初次往储液盒注入泡沫液或更换泡沫液，需执行吸液操作后，可以正常使用绵净泡功能）

## I - 强

- 按此键增强清洗强度。

## K - 水温

- 按此键调节水温档位。
- 正常模式下，水温有四档，指示灯全灭水温约25°C，水温圈温自动调节模式下，增加1档自动档，图标上L3灯亮，

## M - 按摩

- 按此键进入移动冲洗，再次按开启脉冲冲洗，第三次按脉冲/移动同时进行，第四次按冷热交替（仅臀洗），第五次按退出按摩模式。
- （相应功能启动时，移动冲洗时L1亮起，脉冲冲洗时L1，L2亮起，脉冲/移动同时进行L1，L2，L3亮起，冷热交替时L2灯亮起，退出模式全灭。）

## N - 风温

- 按此键进入风温调节。（正常模式下，风温有四档，指示灯全灭为常温）

# 遥控器使用指南

## O - 圈温

- 按此键调节圈温档位，调节座圈加热温度。  
正常模式下，圈温有四档，指示灯全灭为常温，水温圈温自动调节模式下，增加1档自动档，图标上L3灯亮。

## P - 除菌

- 按此键进行全面清洁。（注：此功能运行时，用户落座，无法使用该功能）

## Q - 便盖

- 离座状态下，可按此键进行开/关盖动作。

## R - 座圈

- 离座状态下，可按此键进行开/关圈动作。

## 低电压报警

注意：电压报警后请及时更换电池。

- 当 F 电池报警图标闪烁时，表示遥控器电池电量将耗尽，需要重新更换电池。

## 配对

- 坐便器正常上电，长按风温键2秒以上，档位灯L1,L2,L3在1秒内按顺序依次亮起，保持全亮约0.8秒后，进入配对模式。在遥控器配对模式下，档位灯如跑马灯一样闪烁走动，30秒内。同时按本体侧键盘女用和臀洗，坐便器进入配对模式，蜂鸣器会鸣叫一声。  
遥控器档位灯全亮表示配对成功。  
如30秒内未配对成功，档位灯全灭，需重新配对。

## 遥控器设置指南

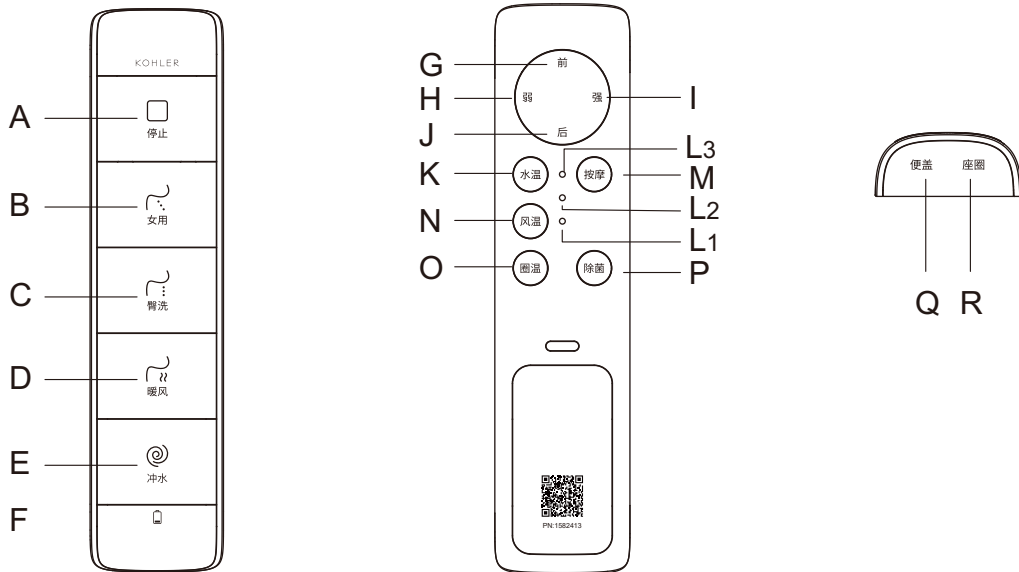

注：按住本体侧键盘大冲键，直到听到一声短音，放开按键，随后可按照以下操作变更设置。

### B - 女用…自动夜灯设置

- 长按此键开启/关闭自动夜灯功能，本体短鸣一声表示开启，长鸣一声表示关闭。

### D - 暖风…自动绵净泡设置

- 长按此键进入自动绵净泡设置模式，短按暖风显示上次状态，再次短按暖风进行状态切换，本体短鸣一声表示开启，长鸣一声表示关闭。

### I - 强…冲水设置

- 长按此键进入自动冲水设置模式，短按强进行状态切换。

1. 档位灯全亮，表示启动不关盖冲水功能。
2. 档位灯L2亮，表示启动关盖冲水功能。
3. 档位灯全灭，表示关闭自动冲水功能。

### H - 弱…自动除臭设置

- 长按此键进入自动除臭设置模式，短按除菌显示上次状态，再次短按除菌进行状态切换。

1. 档位灯全亮，表示启动自动除臭功能。
2. 档位灯全灭，表示关闭自动除臭功能。

# 遥控器使用指南

## K - 水温…水温圈温自动调节设置

- 长按此键进入水温圈温自动调节设置模式，短按水温进行状态切换。
  1. 档位灯全亮，表示启动水温圈温自动调节功能。
  2. 档位灯全灭，表示关闭水温圈温自动调节功能。

## M - 按摩…长落座提醒功能设置

- 长按此键进入长落座提醒功能设置模式，短按按摩进行状态切换。
  1. 档位灯全亮，表示启动长落座提醒功能。
  2. 档位灯全灭，表示关闭长落座提醒功能。

## O - 圈温…节能设置

- 长按此键进入节能设置模式，短按圈温进行状态切换。
  1. 档位灯L1亮，表示关闭节能功能。
  2. 档位灯L2亮，表示启动一般节能功能。
  3. 档位灯L3亮，表示启动深度节能功能。

## P - 除菌…自动除菌设置

- 长按此键进入自动除菌设置模式，短按除菌进行状态切换。
  1. 档位灯全亮，表示启动自动除菌功能。
  2. 档位灯全灭，表示关闭自动除菌功能。

## Q - 便盖…微波档位设置

- 长按此键进入微波档位设置模式，短按便盖进行状态切换。
  1. 档位灯全灭，表示关闭微波功能。
  2. 档位灯全亮，表示启动微波远档功能。
  3. 档位灯L1亮，表示启动微波近档功能。
  4. 档位灯L1, L2亮，表示启动微波中档功能。

## R - 座圈…自动冲水的关盖时长设置

- 长按此键进入自动冲水的关盖时长设置模式，短按座圈键进行状态切换。
  1. 档位灯全亮，表示启动自动关盖时间长档功能。
  2. 档位灯L1亮，表示启动自动关盖时间短档功能。
  3. 档位灯L1, L2亮，表示启动自动关盖时间中档功能。

## J - 后…脚感功能设置

- 长按此键进入脚感功能设置模式，短按后键进行状态切换。
  1. 档位灯全亮，表示启动脚感功能。
  2. 档位灯全灭，表示关闭脚感功能。

注：长按功能按键设置功能时，如用户无任何动作或按其他键，设置功能将退出。  
功能使能提示音短音1声，功能取消停止音长音1声。

## 遥控器电池的使用及更换

- 遥控器使用2节7号碱性电池。
- 当电量不够时，遥控器上红灯闪烁，提示用户需要更换电池。
- 注意：
  1. 电池的正负极必须与遥控器上的标记一致。
  2. 新旧电池不能混用。
  3. 请使用碱性电池。

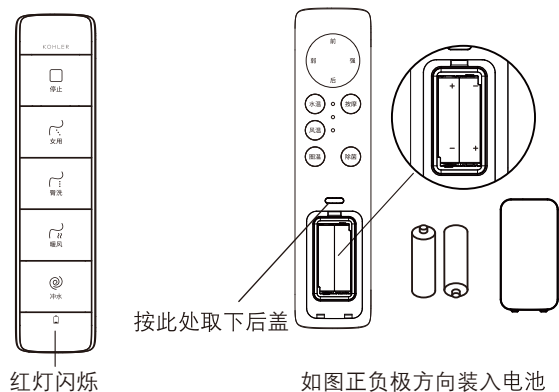

## 其他

- 请勿将遥控器放在液体可能直接喷淋到的地方，或浸泡在液体中。
- 请勿放置在烘手机、电吹风等小型家电的周围，以免干扰遥控器的正常使用。
- 请勿对遥控器的按键区域频繁、剧烈地施加外力。
- 遥控器使用完毕后，应放回墙上的遥控器支架。
- 在使用过程中，避免遥控器跌落。

## 初次使用前准备

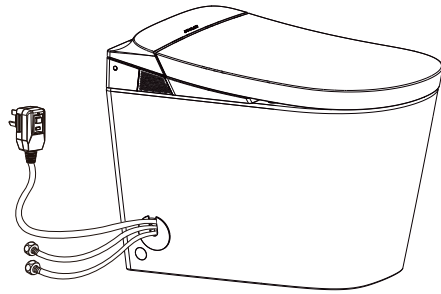

接上进水阀

- 确认进水阀及电源打开。
- 确认“遥控器”内已正确装入电池。
- 确认产品正前方没有障碍物。
- 等待主机完成自检。期间可听到电机的转动声和流水声，均属正常。

- 初次使用时为出厂设置状态：

女性冲洗：

- 水温：中档
- 水流强度：中档
- 冲洗位置：中档
- 脉冲模式：关

臀部冲洗：

- 水温：中档
- 水流强度：中档
- 冲洗位置：中档
- 脉冲模式：关
- 冷热交替 关

圈温：中档

节能功能：关

自动翻盖功能：开

微波感应距离：中距离

自动冲水功能：不关盖冲水

自动夜灯：开

自动UV功能：开

自动除臭功能：开

长时如厕提醒功能：关

水温圈温自动调节功能：关

脚感感应功能：开

自动绵净泡功能：开

以上设置为全功能版本，具体型号的规格差异见产品配置表。

## 便盖/座圈开关功能

### A. 便盖开/关

#### • 自动开、关盖

关盖状态下，当用户进入感应区域时，便盖自动打开。

开盖状态下，当用户离开感应区域后，一段时间后自动关闭。

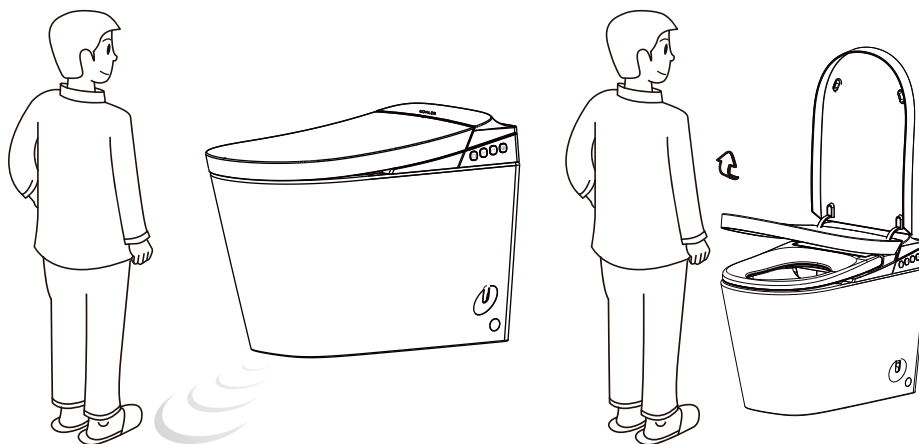

#### • 遥控器开、关盖

用户没有落座时，按下遥控器上的便盖按键，则执行相应的开合功能(详见遥控器按钮简图)。用户落座时，按遥控器的便盖按键无效。

#### • 手动开、关盖

用户可以用手直接开、关盖。当用户有正常手动开、关盖的趋势时，盖子能够根据这个运动趋势而自动打开或关闭，不需要一直在便盖上保持用力。便盖在运动过程中遇阻碍会自动停下。

#### 注意：

1. 当用户缓慢进入感应区域时，开、关盖感应距离可能变短。如仍无反应，请使用遥控器或手动开、关盖。
2. 只有在遥控器中的“微波设置”设置为“开”时，自动开、关盖功能才有效（设置方法见遥控器使用指南页。）
3. 避免在坐便器前端60cm内设置可移动的障碍物，若有可移动的障碍物，便盖可能会自动打开；若需要取消“自动开、关盖”功能，请见遥控器使用指南页。

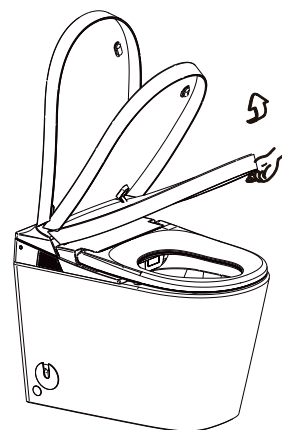

### B. 座圈开/关

#### • 遥控器开、关圈

用户没有落座时，按下遥控器上的座圈按键，则执行相应的开合功能(详见遥控器按钮简图)。用户落座时，按遥控器的座圈按键无效。

## • 手动翻圈

用户可以用手直接开、关圈。当用户正常手动开、关圈时，座圈能够根据这个运动趋势而自动打开或关闭，不需要一直在座圈上保持用力。座圈在运动过程中遇阻碍会自动停下。

注：

在盖板及座圈自动开合过程中，严禁强行、大幅度用力等人为因素干扰便盖及座圈的开合。

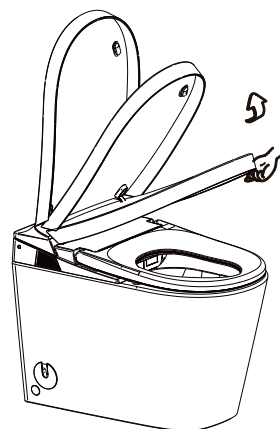

## 便器冲水

### A. 自动冲水功能的使用

#### a) 使用座圈情况

便盖打开状态下，用户落座使用，当离开座圈一定时间后，便器自动冲水，一段时间后自动关闭。

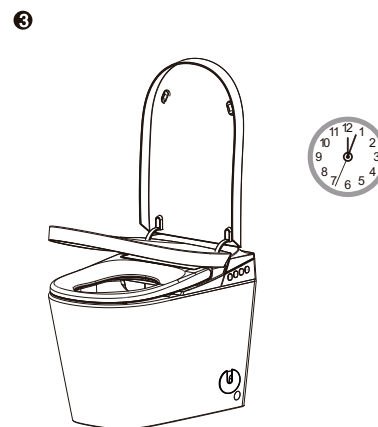
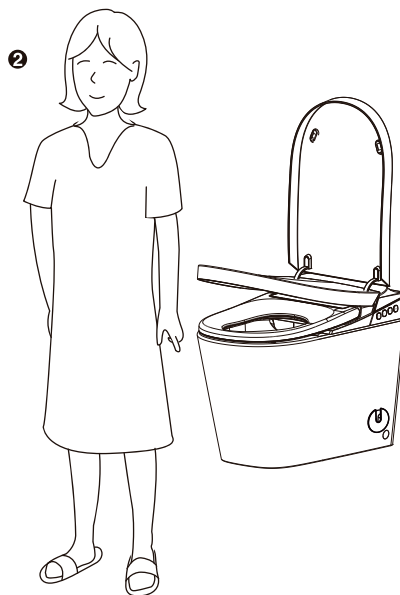

## b) 男士小便情况

开盖状态下，用户手动或者使用遥控器翻起座圈，使用后，坐便器自动冲水，一段时间后，便盖、座圈自动关闭。

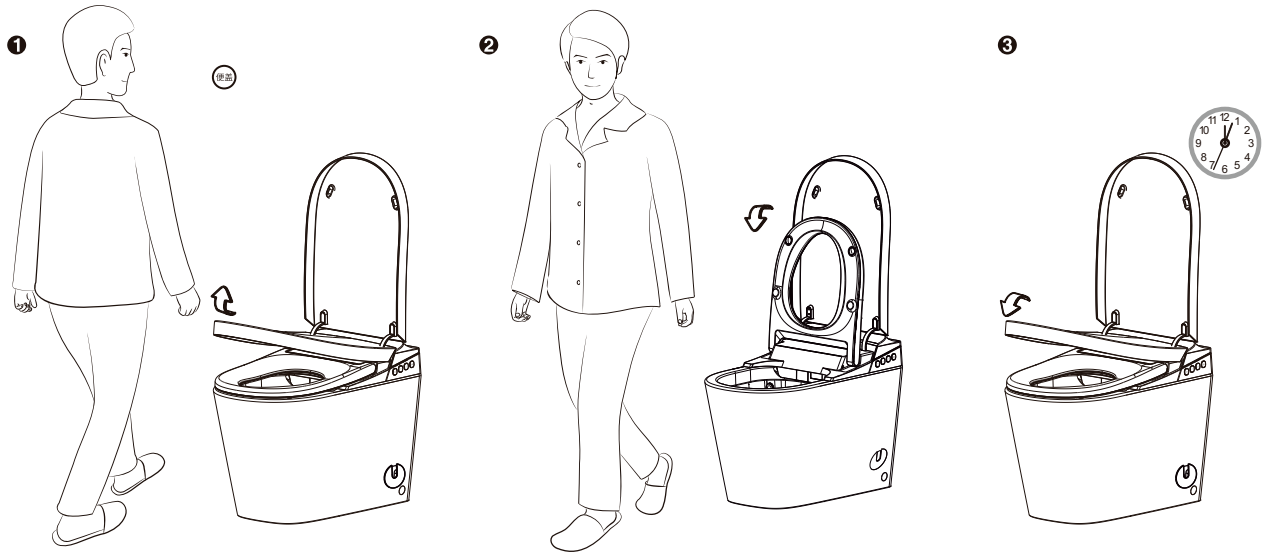

注：

1. 如果自动冲水功能关闭，用户可以用遥控器控制冲水，或手动按键冲水，或手工用盆冲水。
2. 只有在遥控器中的“自动冲水设置”设置为“开”时，自动冲水功能才有效（设置方法见遥控器使用指南）。

## B. 遥控器控制冲水

用户通过按遥控器上的冲水键，执行坐便器冲水功能。

注：遥控器冲水功能约60秒内不会执行第二次自动冲水。

## C. 侧键盘按键冲水

用户还可以直接按坐便器上的侧辅助键盘冲水按键实现冲水。

## D. 紧急冲水

当停电时，用户可以连接备用电池包（整机配件），长按侧键盘冲水按键冲水。

1. 取下陶瓷盖板，从陶瓷装饰盖后面的卡扣中拔出连接线。
2. 将防水DC电源插头连接好，并拧紧防水帽。
3. 如图所示将电池盒放置合适的位置。
4. 盖上陶瓷装饰盖。

注：电池、连接线有正负极之分，请勿强行插入，否则会导致产品损坏。

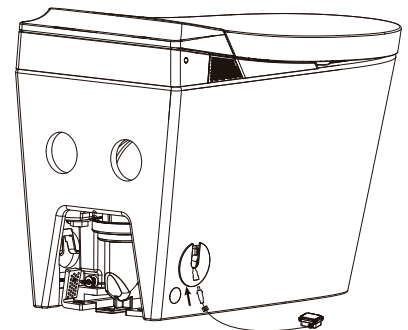

## 绵净泡功能

### A.自动绵净泡功能

#### a) 使用座圈情况

便盖打开状态下，用户落座后，坐便器自动发泡。

#### b) 男士小便情况

开盖状态下，用户手动或者使用遥控器翻起座圈后，坐便器自动发泡

注：1) 自动绵净泡功能20分钟内不会执行第二次自动发泡

2) 只有在遥控器的自动绵净泡功能设置为“开”时自动绵净泡功能才有效（设置方法见遥控器使用指南）

### B.遥控器控制绵净泡功能

长按臀洗键开启手动绵净泡发泡功能。

## 脚感感应功能

用脚触碰感应区域，可进行开/关圈/盖及冲水。在落座状态下，脚感无效。

脚感一下 → 开盖 → 脚感一下 → 开圈、发泡 → 脚感一下 → 冲水 → 脚感一下 → 关圈关盖  
产品设置到关盖冲水模式下，在开圈状态时，脚感一下，关圈+关盖+冲水。

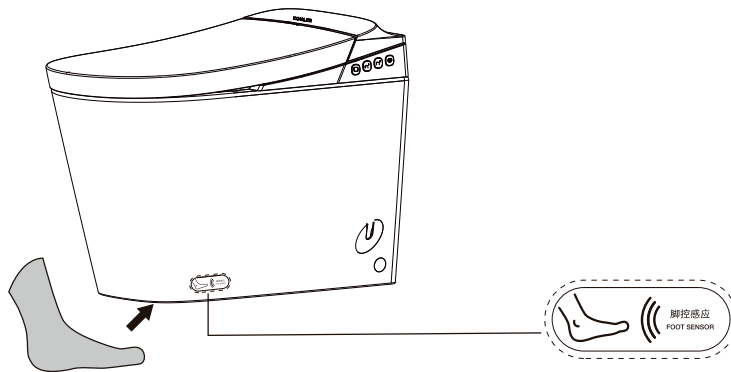

注：1. 只有在遥控器的脚感感应功能设置为“开”时，脚感感应功能才有效（设置方法见遥控器使用指南）

2. 只有在遥控器中的“微波设置”设置为“开”时，启动关盖冲水功能才有效

## 辅助键盘功能

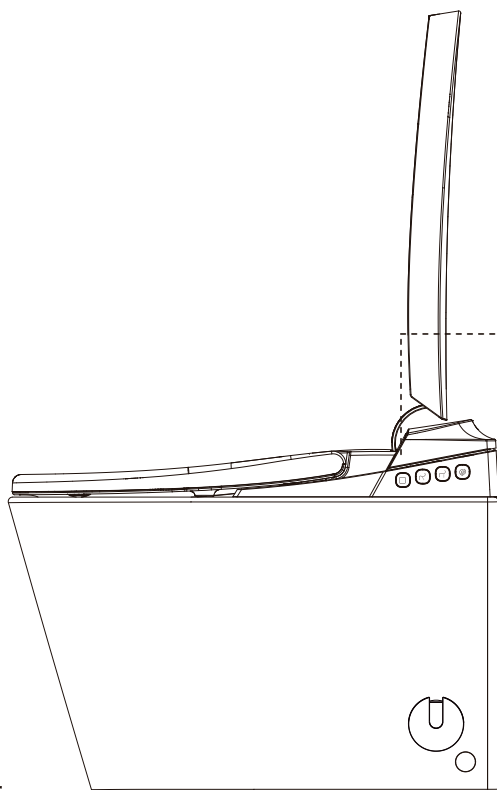

1. 待机模式  
长按停止键两秒以上，进入待机模式，详见42页“待机模式”项。
2. 停止功能  
按一下停止键，停止进行的冲洗功能，暖风功能，除臭功能，手动喷管清洁功能和UV功能/绵净泡。

按下按键进入臀部冲洗



按下按键进入女性冲洗

按下对坐便器缸体进行冲水

### 注:

1. 各功能均按出厂设置运行。
2. 在使用女性冲洗/臀部冲洗功能时，开启相应功能，5分钟后自动关闭。
3. 使用STOP键，可以关闭女性冲洗/臀部冲洗/暖风/除臭/手动喷管清洁/UV功能/绵净泡。

## 待机模式

1. 长按侧键盘上的“⊙”键（2秒以上），进入待机模式。此时，自动感应及遥控功能关闭，座圈加热功能将停止，以最大限度降低能耗。
2. 当按侧键盘任意键或落座后，自动退出待机模式，所有功能恢复。

## UV除菌功能\*

1. UV功能是使用紫外线对喷管进行消毒。
2. 自动UV除菌
  - 如果长时间无人使用，将自动启动UV除菌功能，对喷管进行除菌。除菌结束后24小时之内不会再次启动该功能。
  - UV除菌过程中，如果有用户打开盖子落座使用坐便器，或者按下遥控器上的停止键，UV除菌功能将停止。
  - 自动UV除菌功能设置请参见遥控器使用指南。
3. 手动UV除菌
  - 在无落座的情况下，按遥控器“除菌”按键，可激活UV除菌功能（详见遥控器使用指南）。
  - UV除菌过程中，如果有用户来打开盖子落座使用坐便器，或者按下遥控器上的停止键，UV除菌功能将停止。

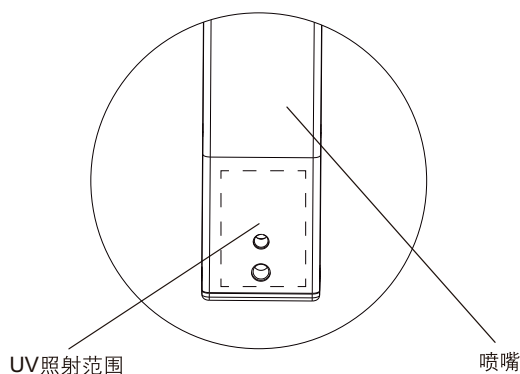

\*UV除菌（是指UV灯产生紫外线除菌）：在UV工作周期内通过照射对喷嘴表面进行除细菌。除菌率大于99%（在UV的一个工作周期后于16mmx8mm的照射区域内依据GB/T 23131进行试验，UV照射区域见示意图，UV工作周期开启方式见操作说明。检测机构：SGS）

## 节能功能

- 在节能设置为开的情况下，一般节能将坐便器加热温度下降，深度节能直接关闭座圈加热，以达到节电的目的。
- 节能设置参见遥控器使用指南。

## 除臭

产品落座情况下，自动开启除臭功能。

按侧键盘或遥控器“⊙”键停止除臭功能。

## 长时如厕提醒功能

长时如厕提醒功能开启后，如果用户长时间落座使用坐便器，超过一段时间后，系统通过蜂鸣器提醒用户。

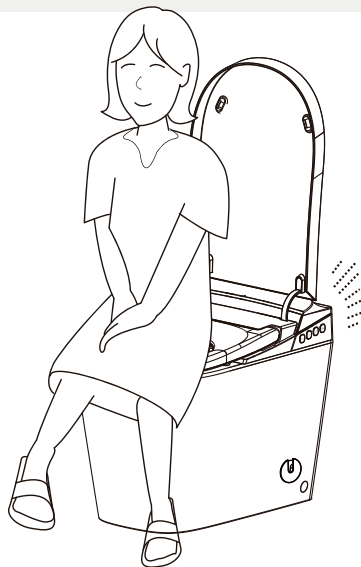

## 水温圈温自动调节功能

在水温圈温自动调节功能为开的前提下，水温圈温设置为自动档时（L3指示灯亮），产品会根据环境温度自动调节对应水温圈温档位。

## 维护和清洗

### A. 常规清洗

为了达到最好的效果，在维护您的科勒产品时记住下列几条：

**重要！不要用水直接冲洗坐便盖（包括遥控器）**

- **测试**-首先用清洗液在坐便盖不显眼的地方测试，如果确认清洗液不会对坐便盖外表造成损坏然后再应用于整个表面。
- **不要让清洁剂浸泡**-不要让清洁剂浸泡产品。
- **避免表面粗糙的材料**-使用柔软、潮湿的海绵或棉质布，不要用表面粗糙的材料来清洗表面，诸如刷子、冲刷垫等。
- **擦洗**-加上清洁剂后，立即用湿布擦洗表面，擦除喷到表面的清洁剂和脏物。

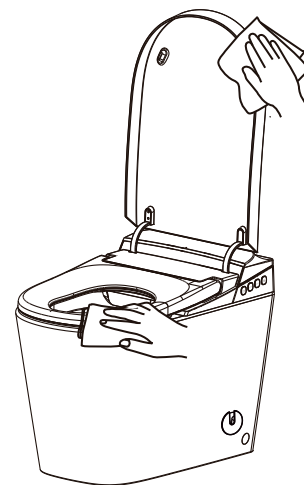

### 清洗座圈

- 在用于清洗的气雾罐中避免使用具有研磨的清洁剂和消毒剂。

**维护提示：**用洗涤剂和水混合液体或任何列为可用于座圈清洁的产品清洗座圈，用柔软湿润的海绵或者布。用软毛巾擦干，在空气中让座圈自然干燥。

- 不允许带腐蚀的化学品或化妆品（诸如指甲油或须后水）和座圈接触，避免破坏表面。

### 清洗不锈钢外观件

- 以中性肥皂水清洗表面，再以干净的软布彻底擦干整个表面。许多清洁剂，比如氨水、去污粉及洁厕灵等，会对表面造成伤害，切忌使用。

**注意：**不遵守这些清洗说明可能使科勒的保修义务无效。

**注意：**清洗程序的成功取决于诸如水的硬度和温度，使用成分的精确数量，清洗规则的改变和被清洗产品的状态等因素。因为这些因素会有变化，科勒不能保证所提到的规则的有效性。

**注意：**清洁翻起的圈盖时，不能使大力，以免损坏产品。

## B. 喷嘴的清洗

用户使用软毛刷清洁喷嘴的方法：

- 在离坐状态下，长按遥控器“前”按键，喷管会伸出。
- 用户可以使用软毛刷沾水对喷嘴进行清洗。
- 按“停止”按键，喷管缩回，或5分钟后喷管自动收回。

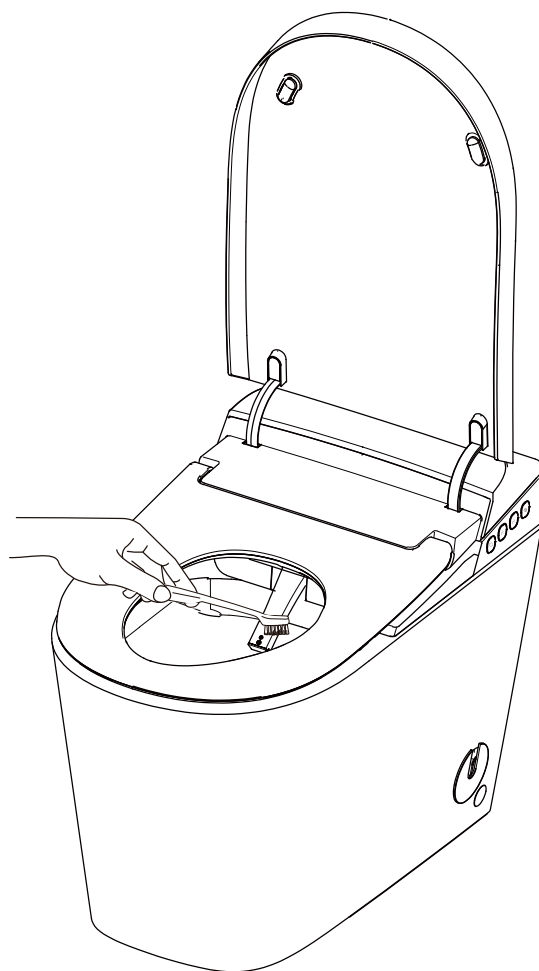

## C. 滤网的清洗或更换

用户发现冲洗水量变小或出现不出水现象，请及时清洗或更换滤网。

### 滤网清洗

- 关闭进水。

①

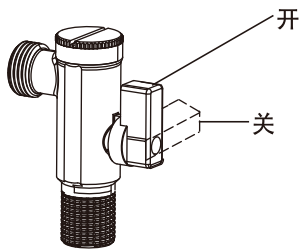

关闭进水阀

- 用一元硬币逆时针旋转打开角阀。

②

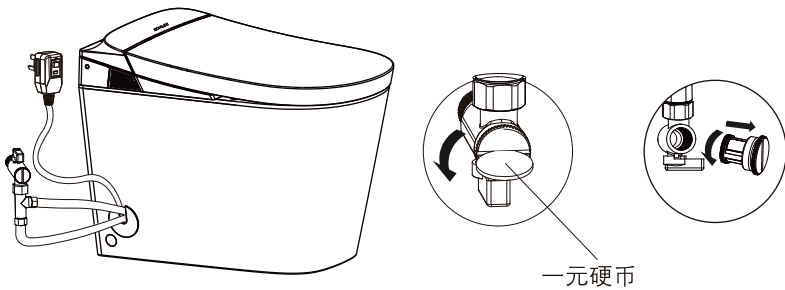

- 重新装好滤网，打开进水阀。
- 检查连接处，无任何水渗漏后。

- 取出滤网，清洗滤网。

③

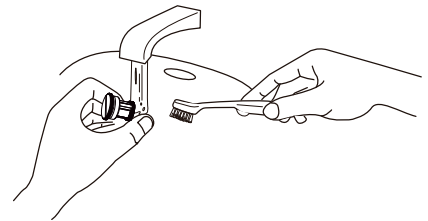

更换滤网步骤同上。

注：

如果发现滤网已损坏或者堵塞很严重，请及时更换。

## D. 除臭模块的更换

用户发现除臭效果不明显，感觉到异味时，请及时更换除臭块。

取出除臭模块步骤：

取出除臭百叶窗及除臭块，更换过除臭块后，重新放回即可。

注：取出除臭块后，请勿将手或者其他物体伸入除臭块容纳腔内，以防损坏风机和其它部件。

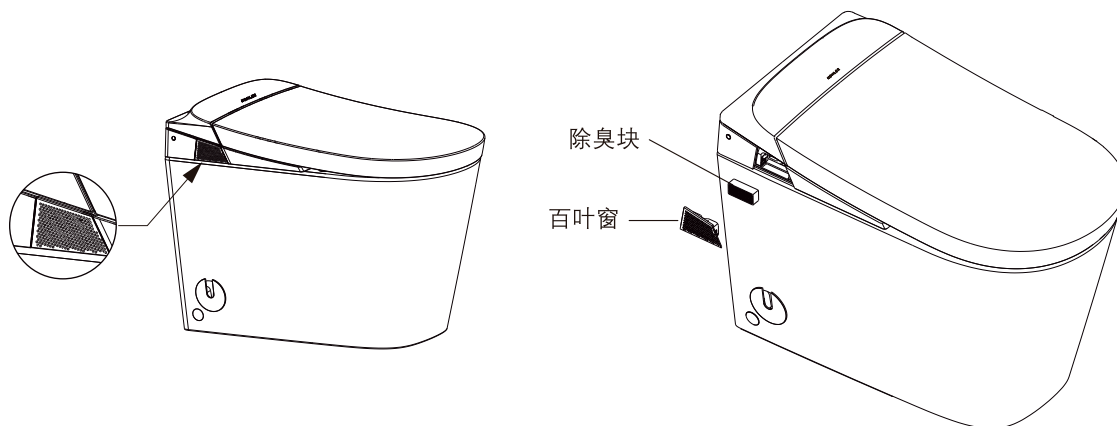

扫码查看替换装，除臭块型号：33998T-NA。

## E. 泡沫液的添加

用户使用一段时间后，发现绵泡净功能发泡量明显减少，需及时补充泡沫液，具体步骤参如下

1. 关闭电源或参考“遥控器使用指南”关闭自动翻圈盖功能。
2. 向上抬起并取下装饰盖板。
3. 按压加液盖并取下加液盖。
4. 打开泡沫液瓶盖，对准加液口，缓慢倒入泡沫液。  
注：一次加液不可超过1瓶(储液罐容积约470ml)，否则会溢出。
5. 把加液盖放回加液口，再将装饰盖板装回原位。
6. 打开电源或参考“遥控器使用指南”恢复自动翻圈盖功能。
7. 使用绵净泡功能前准备，需要长按遥控器“弱”键，再短按“按摩”键进行泡沫液吸液操作。



扫码查看替换装，泡沫液型号：39128T-NA。

## F. 长期放置不用时的维护

a) 如果准备长期不使用智能坐便盖，务必排尽坐便盖内部管路中的积水。

- 拔掉电源，关闭角阀。

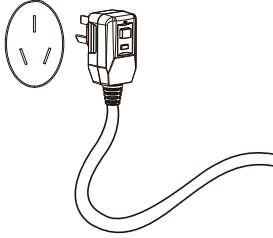

拔掉电源

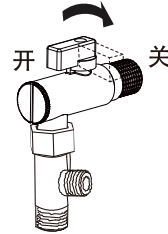

关闭角阀

注：

1. 如果没有排水箱水而又长时间不使用该产品，残留水冬天容易冻结夏天容易变质。
2. 冬天发现家中的供水管道已经冻结，不要马上使用智能坐便器，可以升高室内的温度，等待其自然解冻后再使用。
3. 冬季水管有结冰的风险时，请关闭角阀，并对让马桶进行一次空冲或是进行放水。
4. 长期不使用取出遥控器中的电池。
5. 长期放置不用时，可能会由于马桶里面水分挥发完毕后，下水道的的气体溢出导致塑料件变黄风险，打开便盖或往马桶里面加水可有效避免该问题。

## 疑难解答

本指南仅作参考帮助之用。科勒公司授权的服务代表或者合格电工应当能够解决所有的电气问题。如需了解担保服务，请联系您当地的经销商或批发商。

现象	可能原因	建议措施
1. 坐便器不工作	A. 停电 B. 插头未插或者插座无电 C. 电源线插头上漏电保护开关未复位 D. 产品处于待机状态	A. 等到电力恢复 B. 插上插头或者检测电源插座 C. 按下插头上的复位按钮 D. 按一下侧面“⊙”按键
2. 坐便器不冲水	A. 停水 B. 供水角阀关闭 C. 停电 D. 产品处于待机状态 E. 清洗功能正在使用中 F. 自动冲水功能被禁止	A. 等到恢复供水 B. 打开供水角阀 C. 等待恢复电力或者查看“手动冲洗”部分进行手动冲洗或者用盆盛水冲洗。 D. 按一下侧面“⊙”按键 E. 待清洗功能完成再进行 F. 查看“遥控器设置指南”部分
3. 清洗功能无法正常使用	A. 停水 B. 供水角阀关闭或者未完全打开 C. 没有入座或者当前坐姿无法使座圈感应到 D. 过滤网或滤芯堵塞 E. 供水水压不足	A. 等到恢复供水 B. 完全打开供水角阀 C. 请入座或者调整坐姿 D. 查看“清洗过滤网或滤芯更换”部分 E. 检查进水软管是否折弯过急，如折弯过急，请调整软管
4. 使用过程中冲洗功能停止工作	A. 连续冲洗5分钟后冲洗功能自动停止 B. 座圈未感应到人体	A. 如需要，请再次按下冲洗按键 B. 变换坐姿或者重新入座
5. 人体未入座时也能使用清洗功能	A. 座圈上有异物覆盖或者座圈是湿的	A. 移除异物或者擦干座圈
6. 使用过程中暖风风机停止工作	A. 连续使用暖风功能4分钟，风机自动停止 B. 座圈未感应到人体	A. 如需要，请再次按下暖风按键 B. 变换坐姿或者重新入座
7. 除臭风机不工作	A. 使用过程中误按停止键 B. 自动除臭功能被禁止	A. 如需要，请离座2秒后重新入座 B. 查看“遥控器设置指南”部分
8. 不能开关盖	A. 座圈上有异物覆盖或者座圈是湿的 B. 便盖在先前开关过程中受到人为干扰	A. 移除异物或者擦干座圈 B. 使用遥控器开关便盖或手动打开便盖直至正常，便盖开关过程中不阻挡其开关
9. 不能自动开关盖	A. 用户没有进入或离开感应区域 B. 遥控器“自动翻盖”功能被关闭 C. 坐便器正在冲水中	A. 请进入或离开感应区域 B. 查看“遥控器设置指南”部分 C. 等待坐便器冲水结束
10. 智感除菌不工作	A. 有人坐在坐便器上 B. 座圈上有异物覆盖或者座圈是湿的	A. 请离座后关闭盖子再重新开启紫外线杀菌及关闭坐便器 B. 移除异物或者擦干座圈
11. 遥控器不工作	A. 电池电量耗尽 B. 电池极性装反	A. 更换新电池 B. 重新正确安装
12. 遥控器无法遥控坐便器	A. 电池电量不足 B. 遥控器离坐便器太远 C. 坐便器本机没有上电 D. 坐便器本体处于待机状态 E. 坐便器与遥控器未连接	A. 查看“遥控器电池的使用及更换”部分来更换电池 B. 查看“遥控器与本机的通讯”部分并靠近坐便器 C. 请给本体上电 D. 按一下侧面“⊙”按键或落座 E. 查看“遥控器与本机的通讯”部分，连接坐便器与遥控器

13. 座圈不热	<ul style="list-style-type: none"> <li>A. 遥控器的圈温设置太低</li> <li>B. 坐便器处于待机模式</li> <li>C. 整机进入节能模式</li> </ul>	<ul style="list-style-type: none"> <li>A. 将圈温设置到合适档位</li> <li>B. 按一下侧面的“⊙”键</li> <li>C. 退出节能模式，查看“遥控器设置指南”部分</li> </ul>
14. 夜灯不亮	<ul style="list-style-type: none"> <li>A. 夜灯功能被关闭</li> <li>B. 室内光线太亮</li> </ul>	<ul style="list-style-type: none"> <li>A. 查看“遥控器设置指南”中夜灯部分来打开夜灯功能</li> <li>B. 请完全遮挡住感光窗口</li> </ul>
15. 启动绵净泡功能时，泡沫不连续	<ul style="list-style-type: none"> <li>A. 第一次启动绵净泡功能时，储液罐内有空气排除</li> <li>B. 刚使用完冲水功能，坐便器仍处于补水状态</li> <li>C. 机器储液盒内泡沫液用尽</li> </ul>	<ul style="list-style-type: none"> <li>A. 属于正常现象，多启动几次后，此现象会消除</li> <li>B. 请等待坐便器补水完成，再启动绵净泡功能</li> <li>C. 及时补充泡沫液</li> </ul>

# 产品中有害物质含量的说明

## 回收提示

本产品超过使用期限或经过维修无法正常使用后，不应随意丢弃，请交由有废弃电器电子产品处理资质的企业处理，正确的处理方法请查阅国家或当地有关废旧电器电子产品处理的规定。

## 有害物质统计表

名称	有害物质名称									
	铅 (Pb)	汞 (Hg)	镉 (Cd)	六价铬 (Cr(VI))	多溴联苯 (PBBs)	多溴二苯醚 (PBDEs)	邻苯二甲酸二正丁酯 (DBP)	邻苯二甲酸二异丁酯 (DIBP)	邻苯二甲酸丁苄酯 (BBP)	邻苯二甲酸二(2-乙基)己酯 (DEHP)
塑料组件	○	○	○	○	○	○	○	○	○	○
控制类组件	X	○	○	○	○	○	○	○	○	○
PCBA组件	X	○	○	○	○	○	○	○	○	○
电机类组件	X	○	○	○	○	○	○	○	○	○
导线类组件	○	○	○	○	○	○	○	○	○	○
进水组件	○	○	○	○	○	○	○	○	○	○
*喷管组件	○	○	○	○	○	○	○	○	○	○
加热组件	X	○	○	○	○	○	○	○	○	○
*遥控器组件	X	○	○	○	○	○	○	○	○	○
*电池	○	○	○	○	○	○	○	○	○	○
*陶瓷类组件	○	○	○	○	○	○	○	○	○	○
*水箱组件	○	○	○	○	○	○	○	○	○	○

注1：○：表示该有害物质在该部件所有均质材料中的含量均不超出电器电子产品有害物质限制使用国家标准要求。

×：表示该有害物质至少在该部件的某一均质材料中的含量超出电器电子产品有害物质限制使用国家标准要求。

注2：以上未列出的部件，表明其有害物质含量均不超出电器电子产品有害物质限制使用国家标准要求。

\* 表示部分机型含有该部件。

注：本表格提供的信息是基于供应商提供的数据及科勒公司的检测结果。本产品应用环保设计理念，在当前技术水平下，所有有害物质或元素的使用已经控制到了最低程度，科勒公司会继续努力通过改善现有技术来减少这些物质的使用。



本产品的“环保使用期限”为10年，科勒公司根据产品设计特性指定该期限。只有在本产品使用说明书所述的正常情況下使用本产品时，“环保使用期限”才有效。